



“Milestone Moment” Webinar

March 30, 2022

Guru Parulkar, Larry Peterson, Saurav Das,
Oğuz Sunay, Aseem Parikh, William Snow, Timon Sloane

The Big Announcement

ONF has open-sourced its entire portfolio of projects

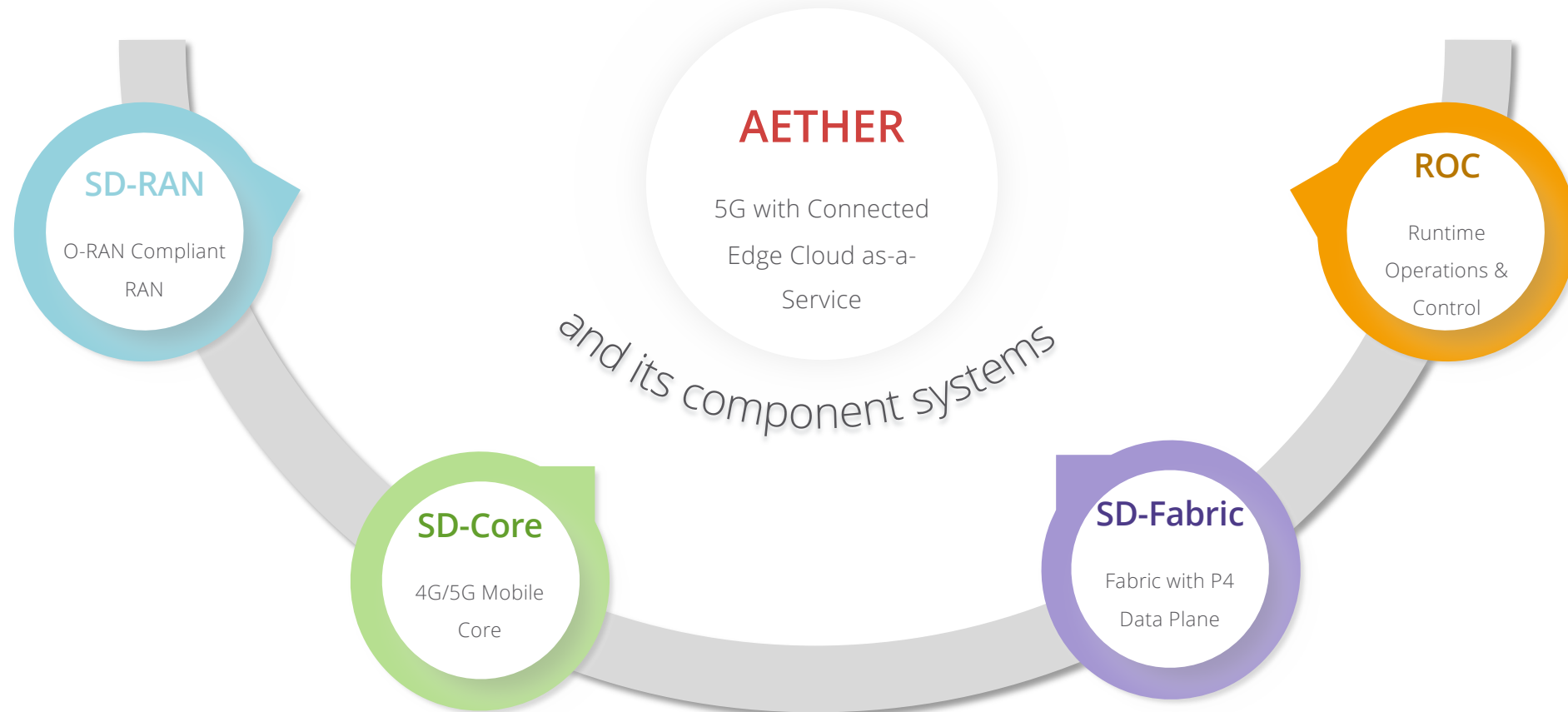

Key Attributes of ONF Platforms

Aether and its component platforms all share the following attributes

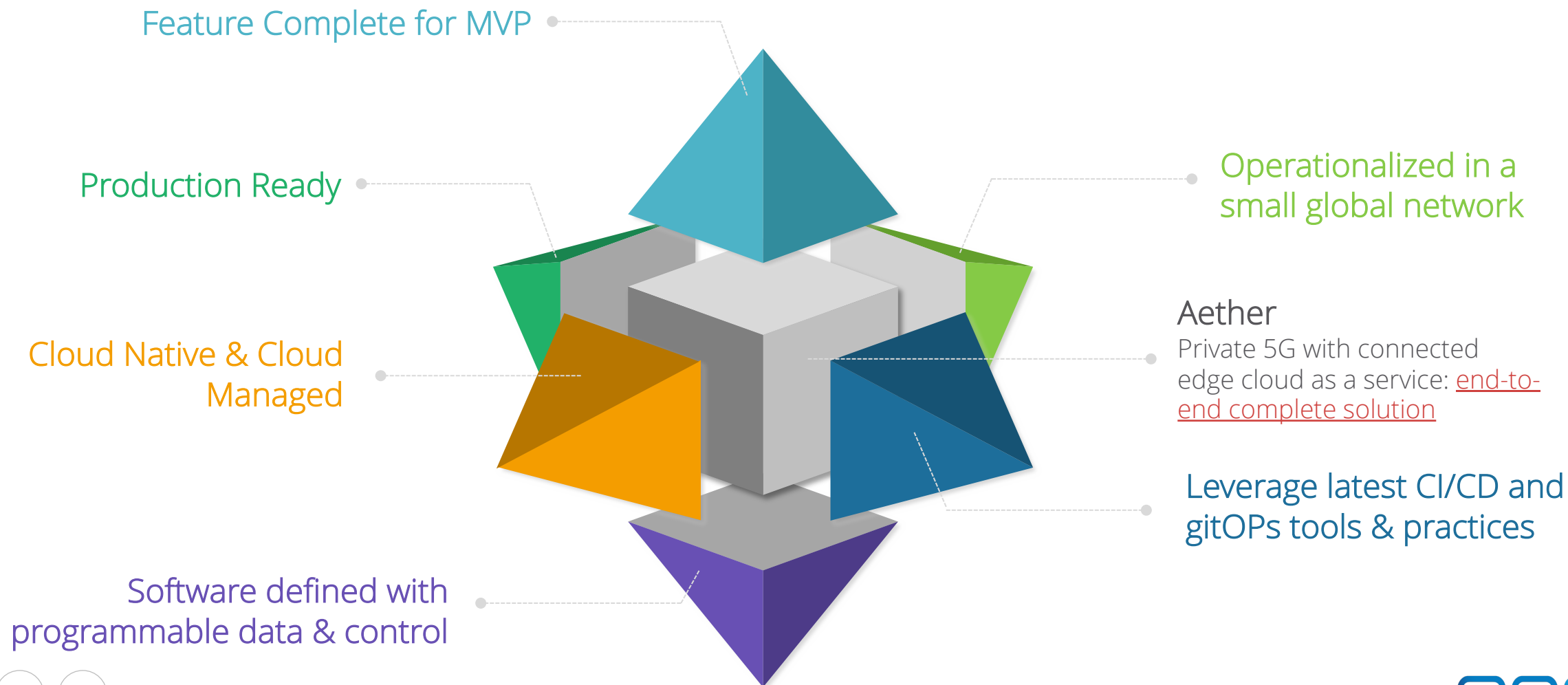

Significance of the Announcement

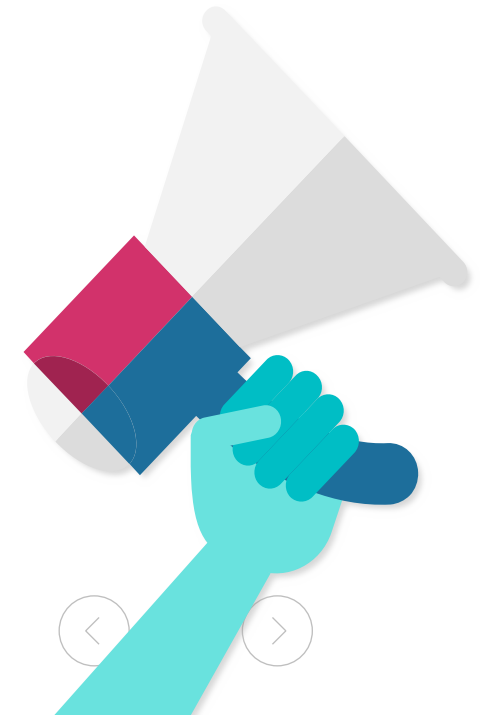

New Era for 5G/Next G and Edge: Accelerated Path to Production



Enable **application** developers to realize the full potential of 5G and Edge for enterprise digital and industry 4.0 transformation

Take innovations and applications of 5G/Next G to production with:

- (i) significantly reduced **R&D investment** and
- (ii) Faster **time to market**

For a huge emerging market

Aether provides an accelerated path to building your own network (or your own 5G/Next G & Edge product)

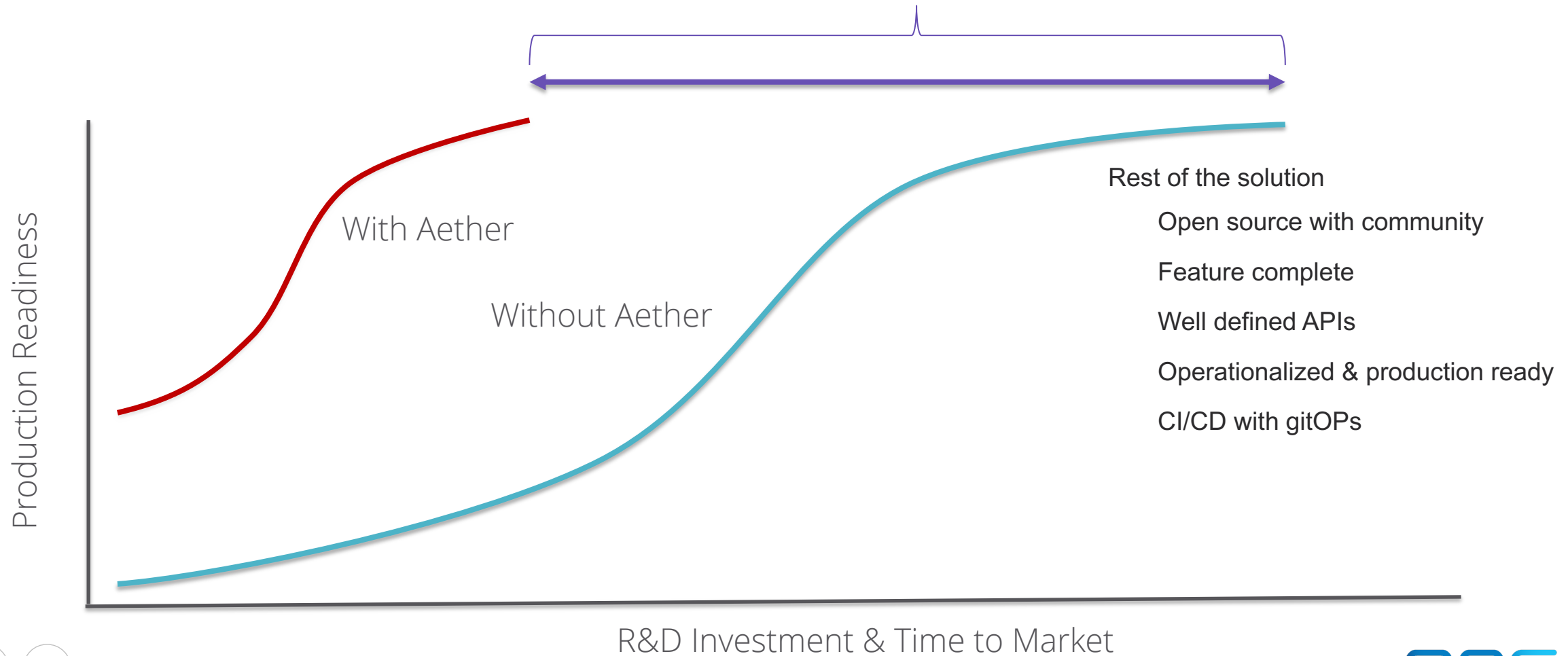

ONF Committed to Help Community

Come and Join
to Realize the Full Potential of 5G + Edge for Industry 4.0

How did we get here?

Agile Process + Architectural Coherence

Larry Peterson
CTO

Agile Process + Architectural Coherence

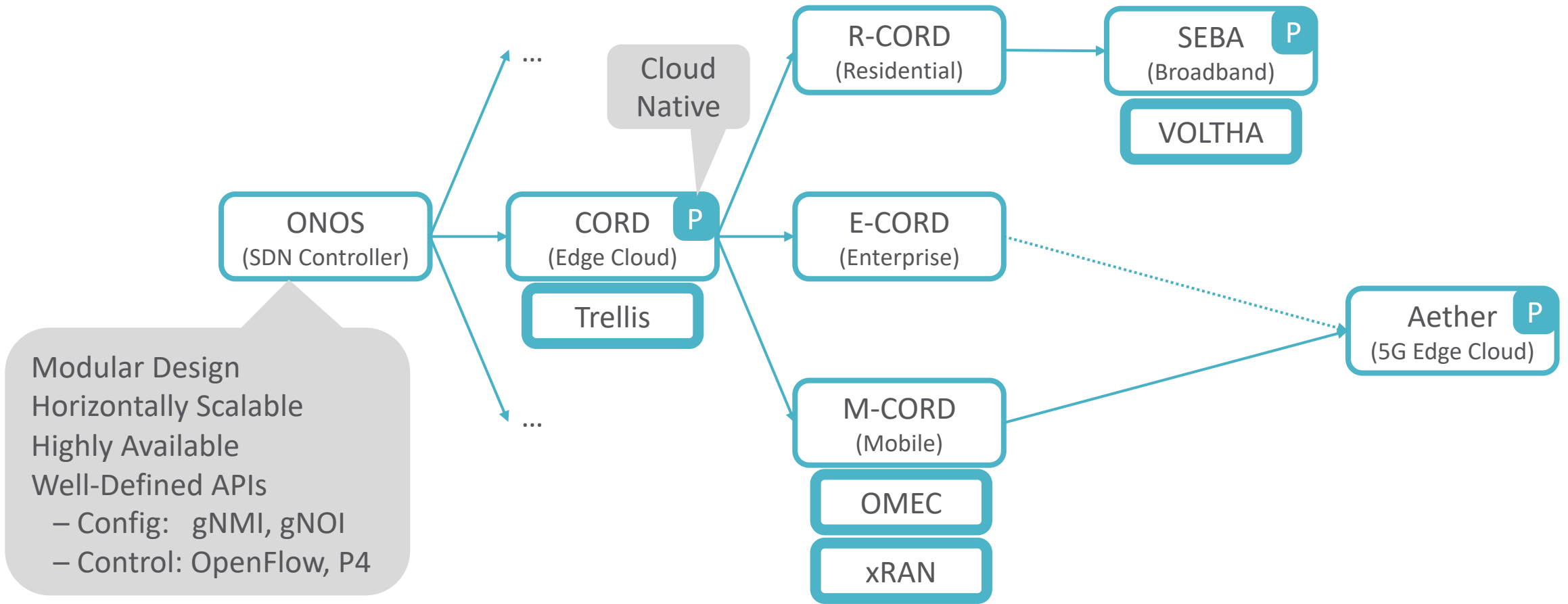

Modular Design
Horizontally Scalable
Highly Available
Well-Defined APIs
– Config: gNMI, gNOI
– Control: OpenFlow, P4



Agile Process + Architectural Coherence

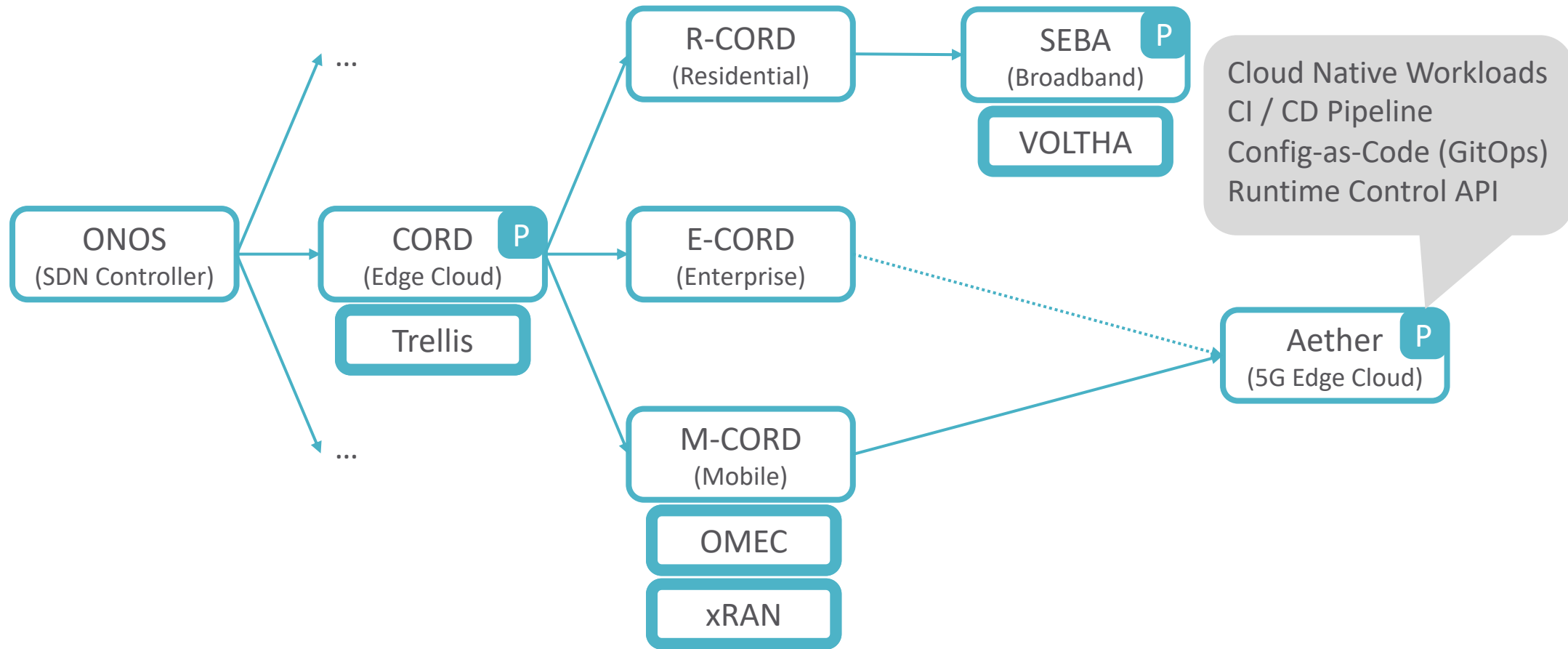

Timeline

2012

2022

SD-Fabric, SD-Core, SD-RAN

Saurav Das
VP Engineering

SD - *

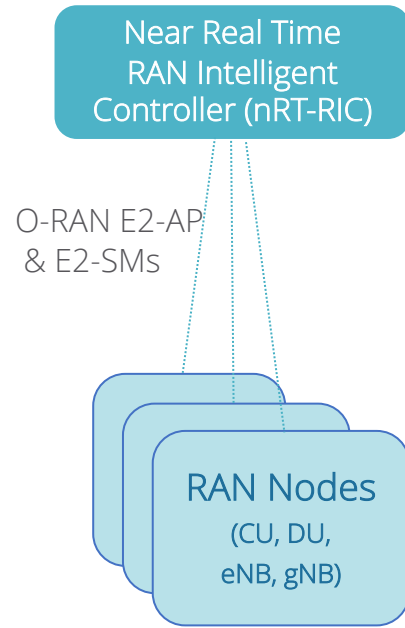

SD-RAN

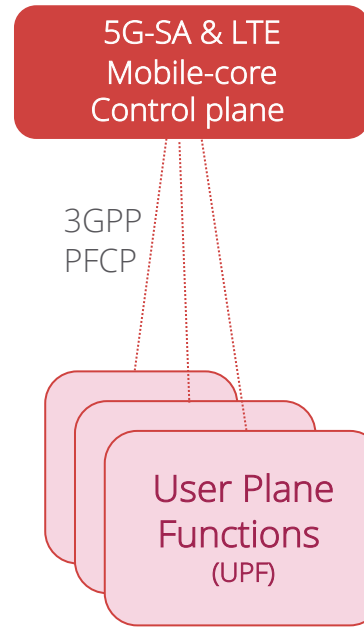

SD-Core

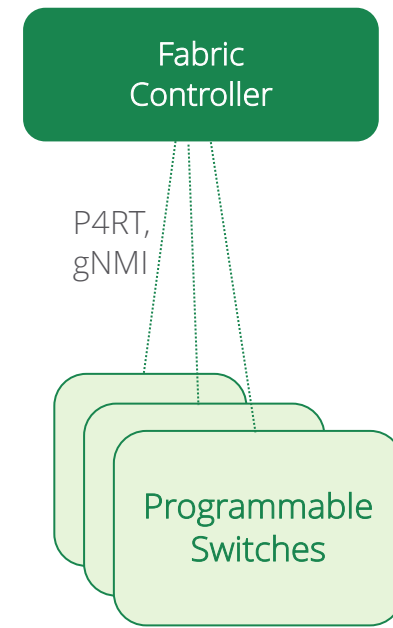

SD-Fabric

SD-RAN's μ ONOS-based nRT-RIC

cloud-native microservices architecture

app-SDKs are a collection of APIs and tools in different languages that allow xApps to interact with RIC platform services

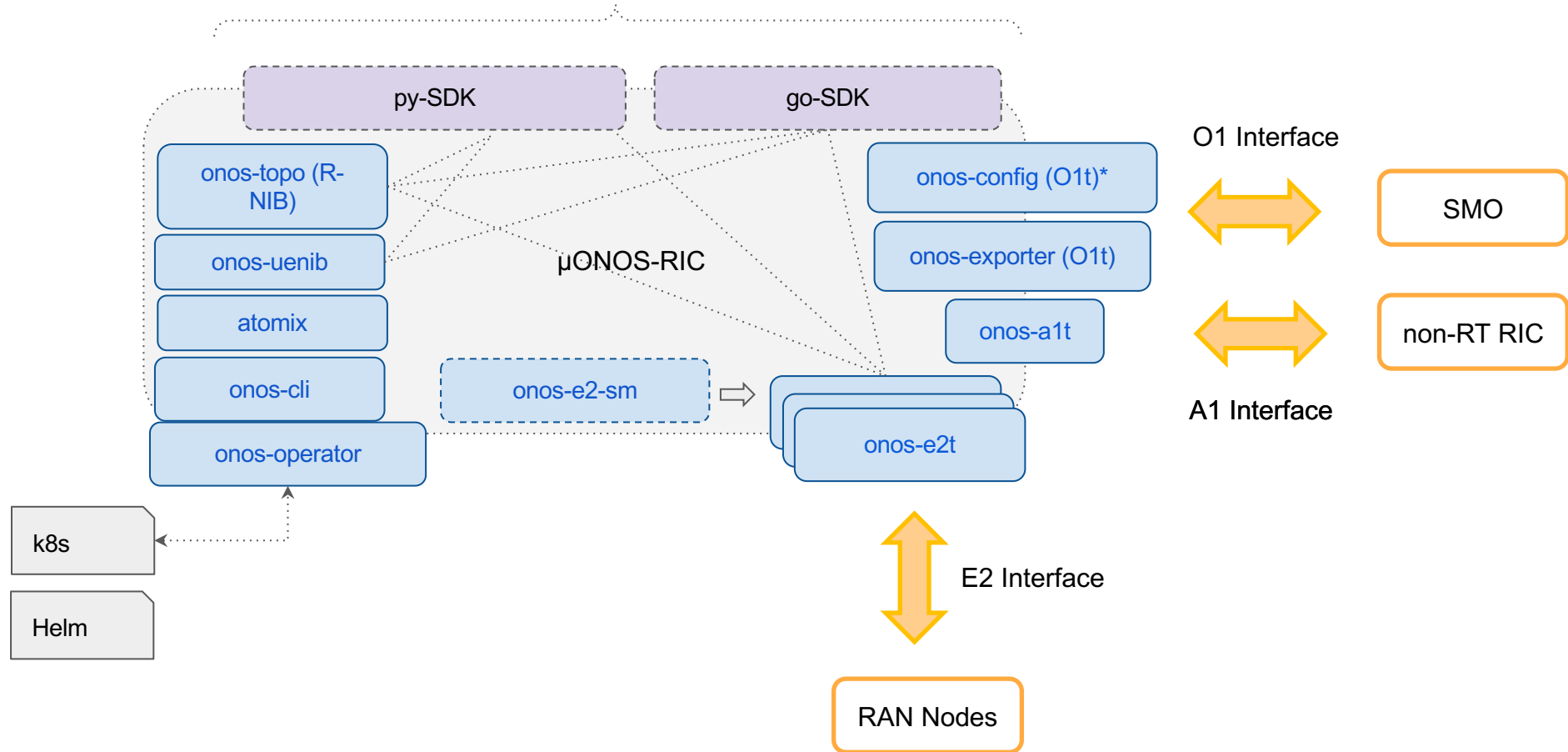

SD-RAN Project

xApps developed by ONF and 3rd party companies

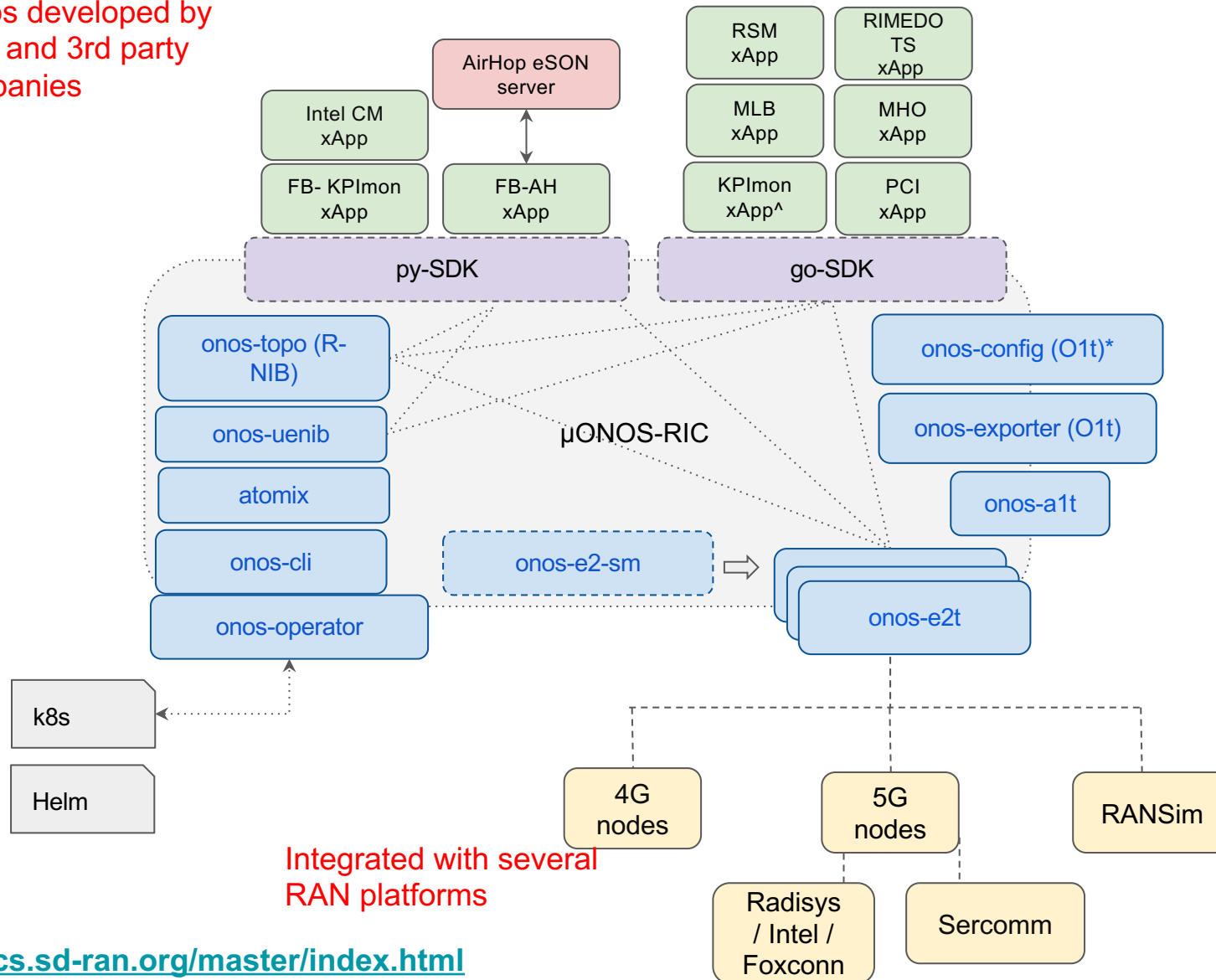

O-RAN Standardized & Pre-standard SMs

O-RAN E2AP v1.0.1, v2.0
O-RAN KPM v2.0 SM
RC-PRE v2.0 SM
MHO v1.0, v2.0 SM
RSM 1.0 SM

Integrated with several RAN platforms

Learn more: <https://docs.sd-ran.org/master/index.html>

SD-Core Project

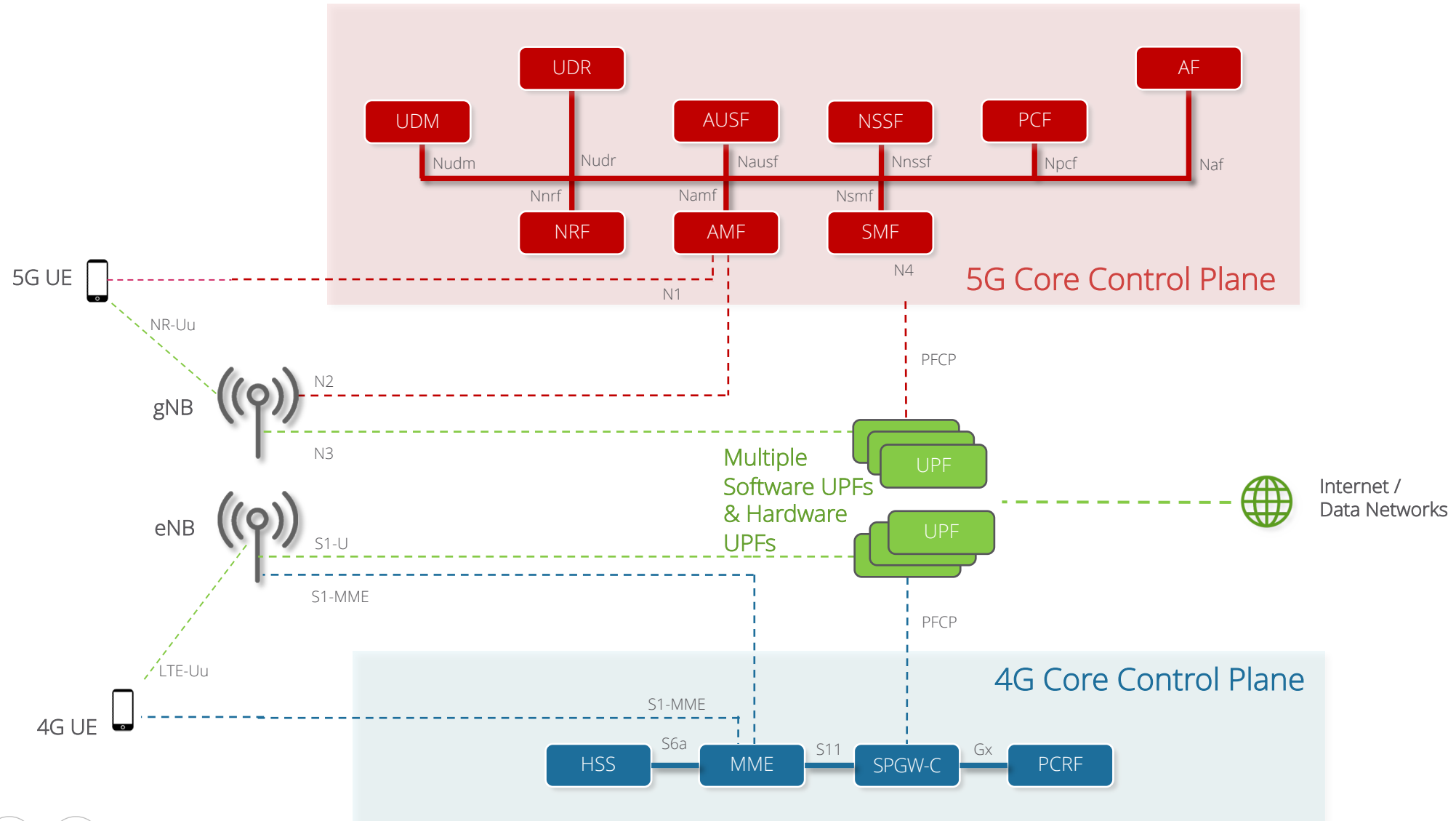

SD-Core Deployment Flexibility

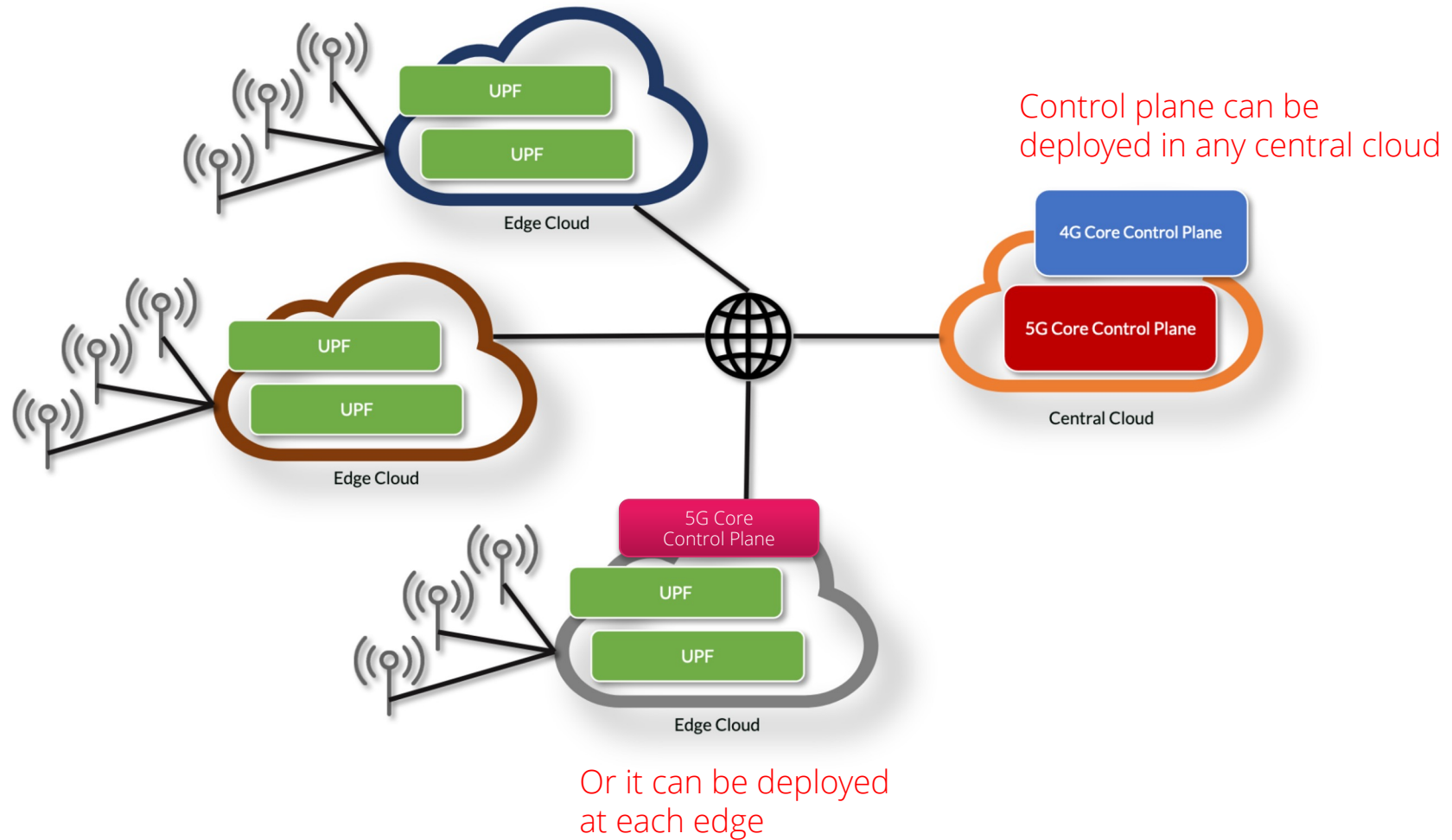

SD-Core Configuration Abstractions

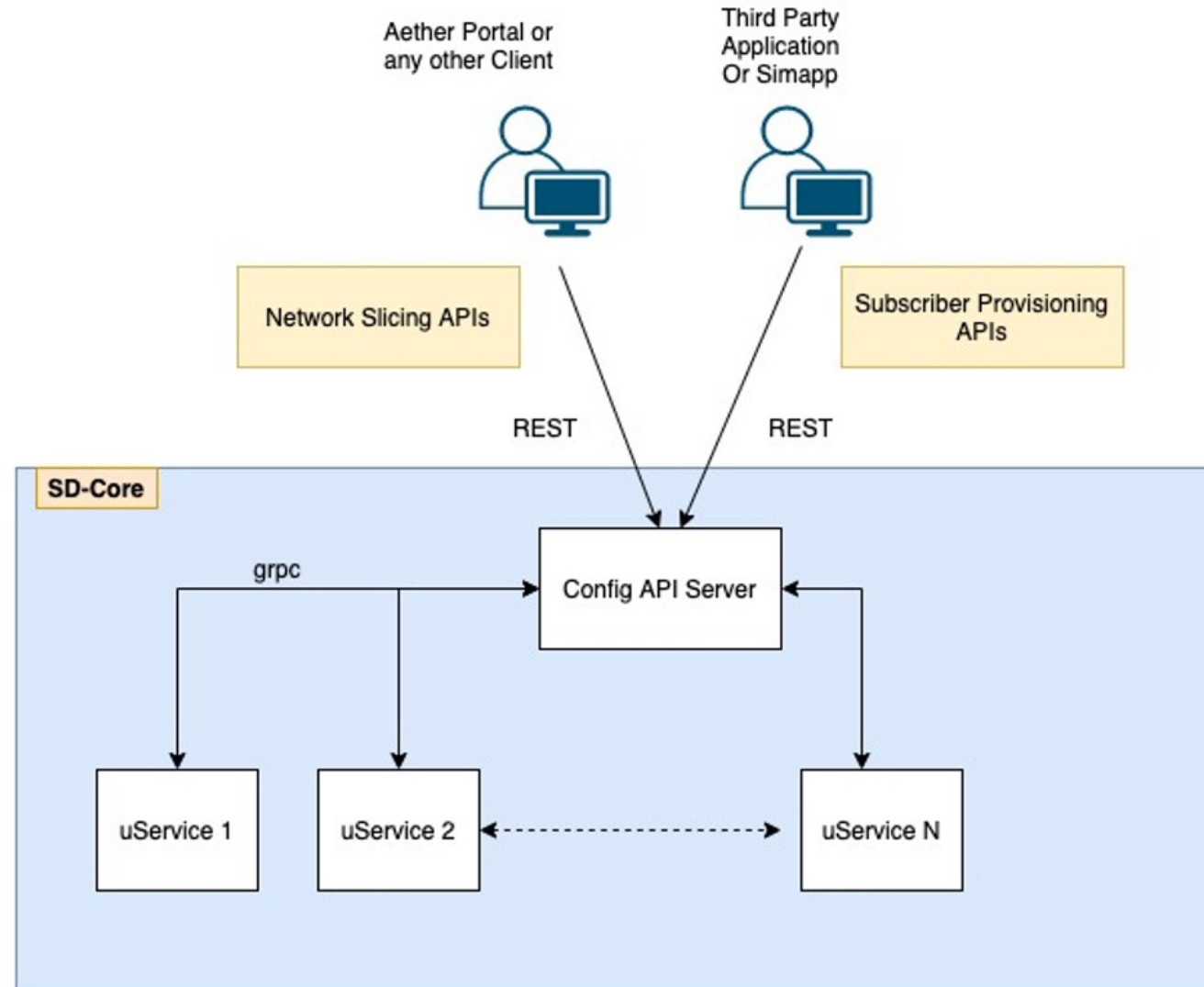

SD-Core provides an abstraction for mobile networks; that allow common configuration APIs for 4G & 5G cores

Config-server distributes configuration to individual microservices (network functions) that make up the 4G and 5G cores

SD-Fabric

API driven
Fully programmable switches
Visibility throughout the network

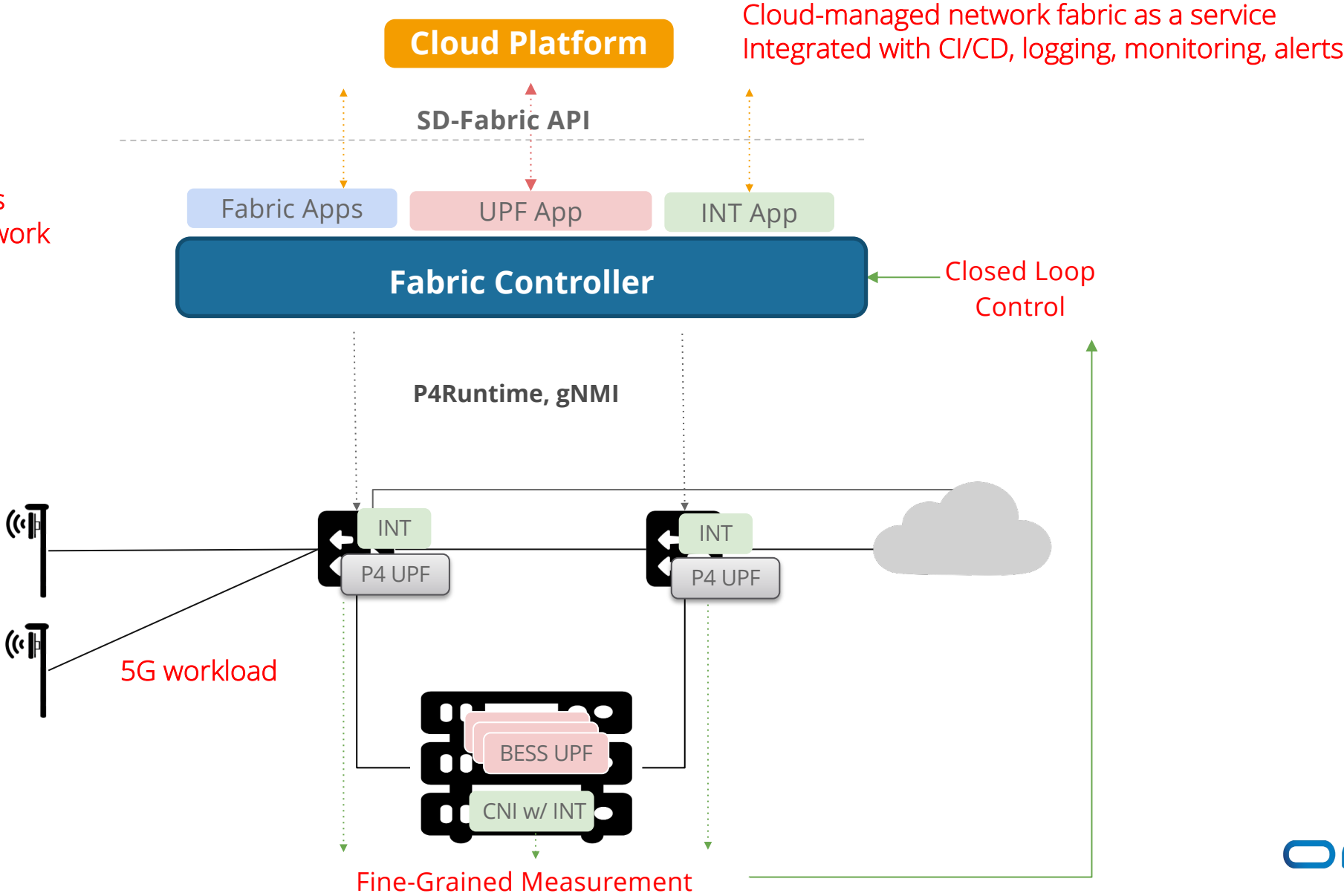

SD-Fabric Scalability and Redundancy

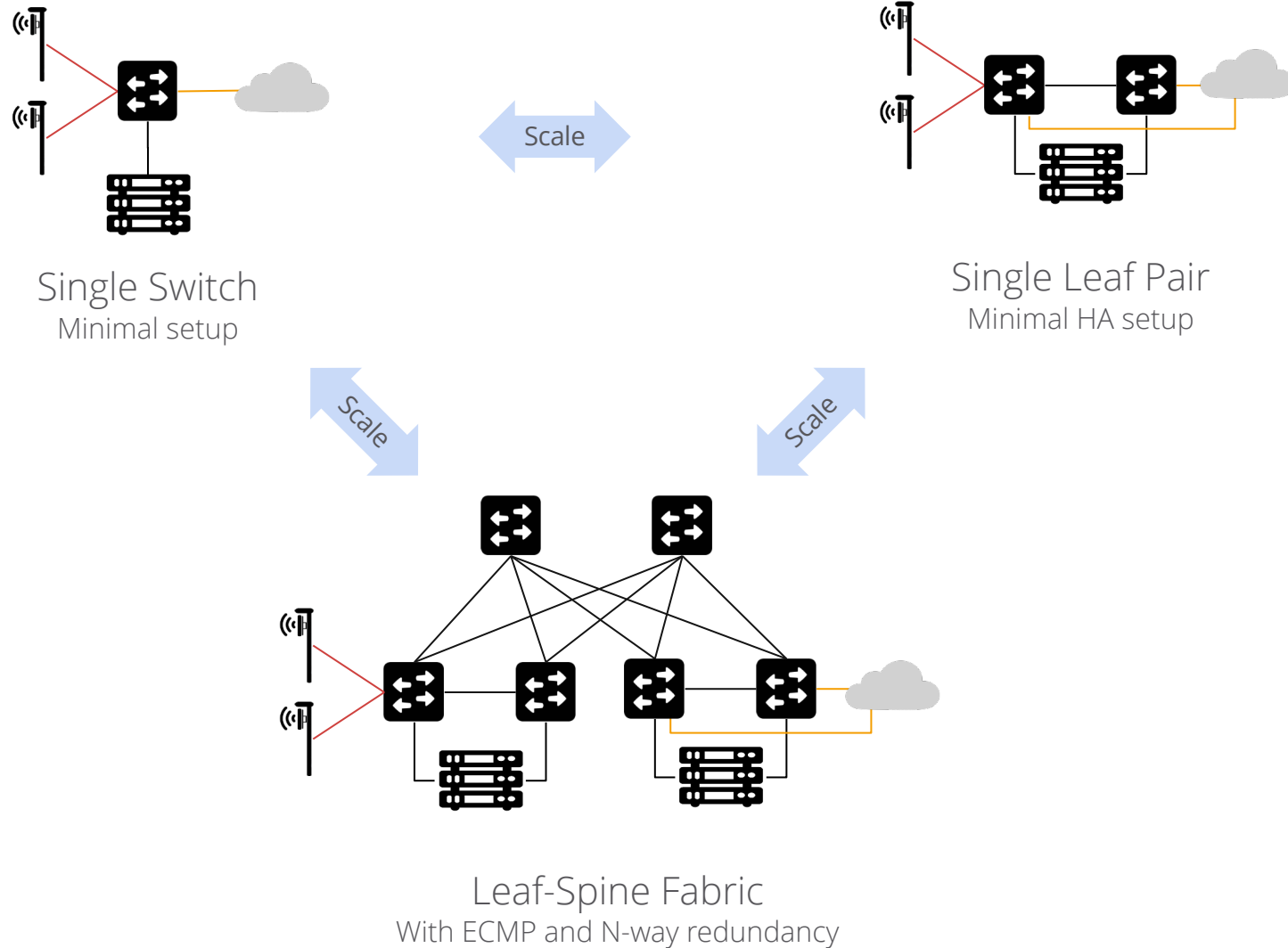

SD-Fabric + SD-Core

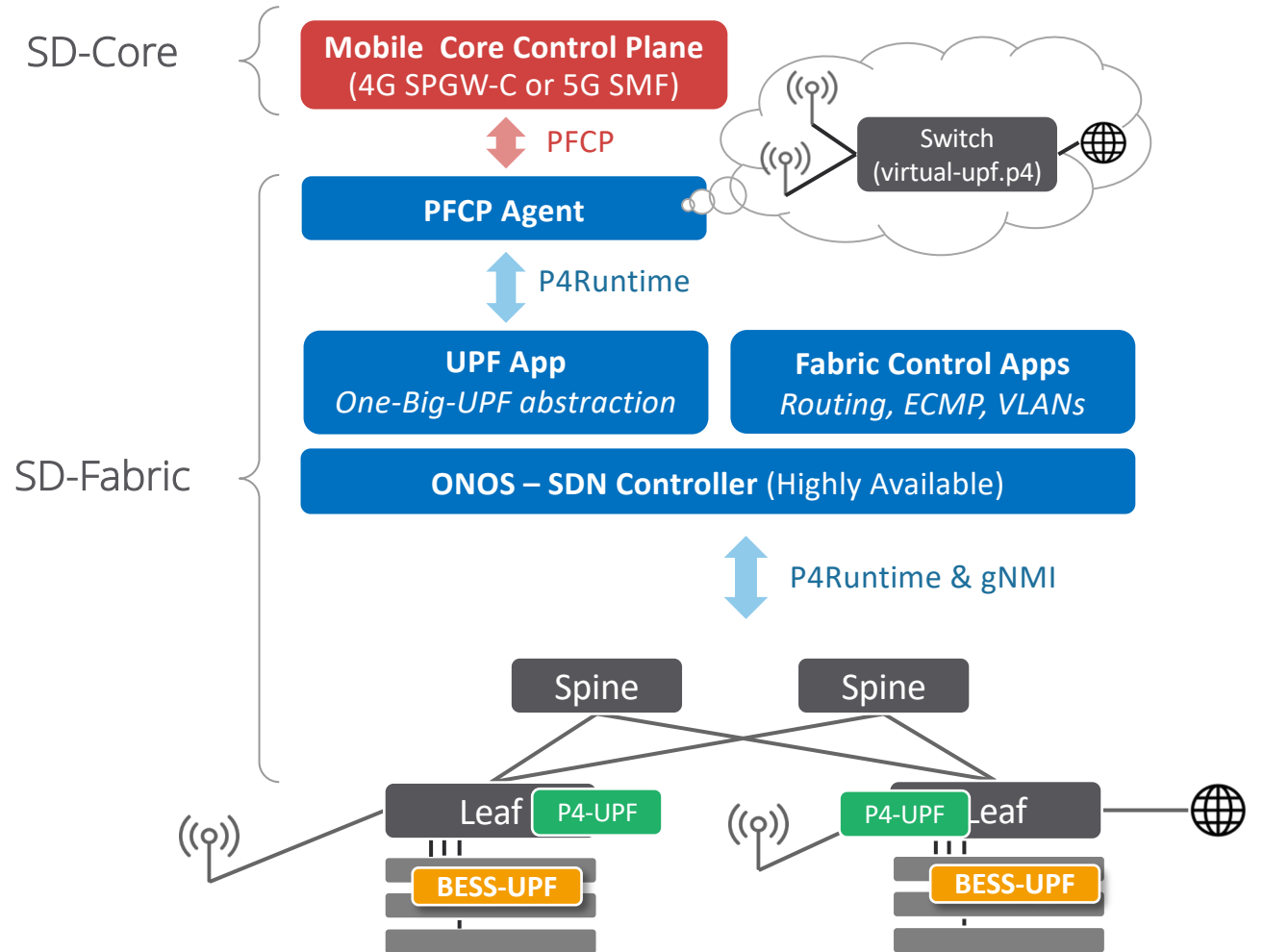
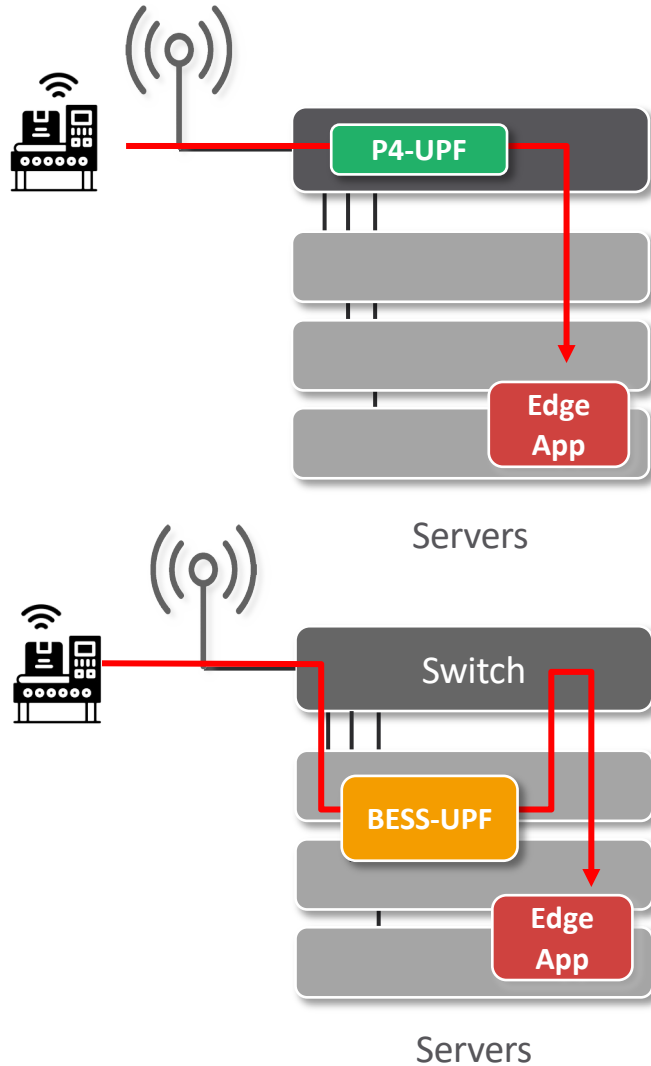

Get Involved



Resources

- [Website](#)
- [Wiki](#)
- [Whitepaper](#)
- [Docs](#)
- [SD-RAN YouTube channel](#)
- [Presentations](#)

Preferred means of communication

- #sdran-dev channel in [ONF Community Slack](#)
- [sdran-dev mailing list](#)



Resources

- [Website](#)
- [Whitepaper](#)
- [Wiki](#)
- [Docs](#)
- [SD-Core 2021 Review](#)

Preferred means of communication

- #sdcore-dev channel in [ONF Community Slack](#)
- [SD-Core mailing list](#)



Resources

- [Website](#)
- [Whitepaper](#)
- [Docs](#)
- [Wiki](#)

Preferred means of communication

- #sdfabric-dev channel in [ONF Community Slack](#)
- [SD-Fabric developer mailing list](#)

Aether

Oğuz Sunay
VP of R&D - Mobility

Aether for Enterprise 5G

5G Made Simple

Plug-and-play - simple to deploy, integrate and operate, aiming to accelerate 5G adoption at scale at enterprises

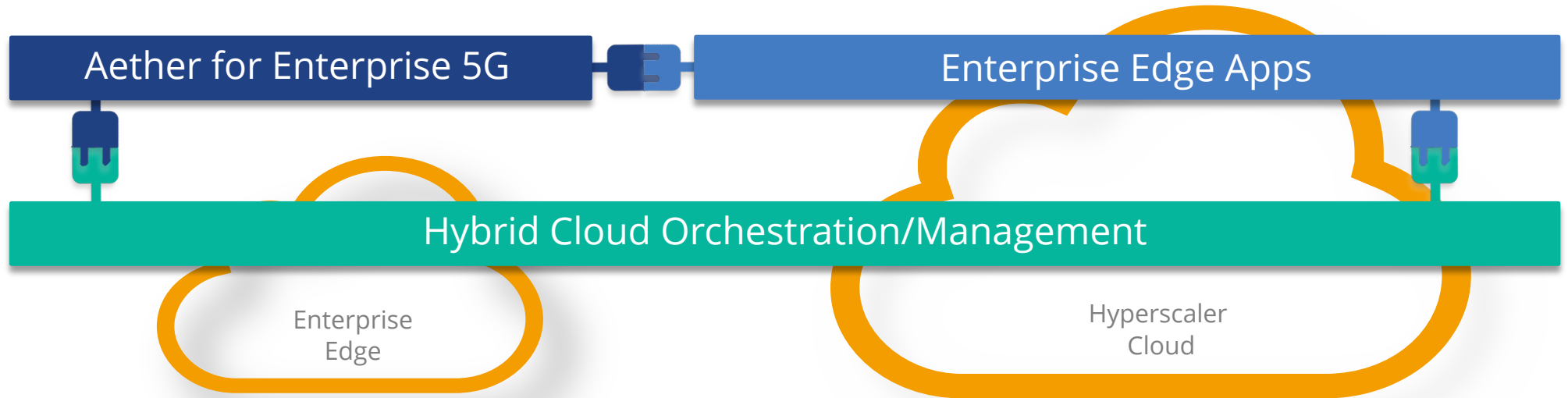

Sum is greater than the components: Aether stack

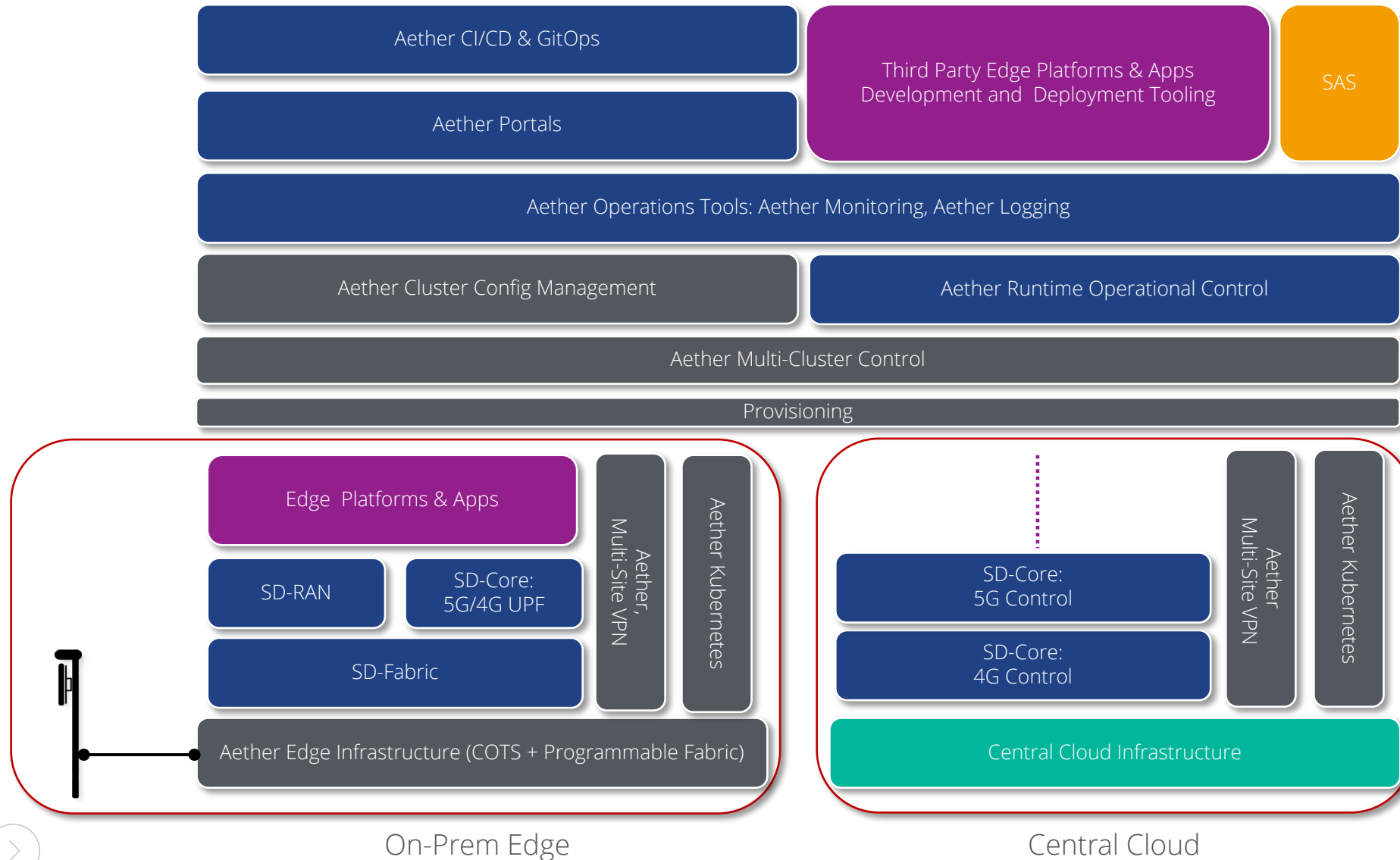

Aether's CI/CD and GitOps

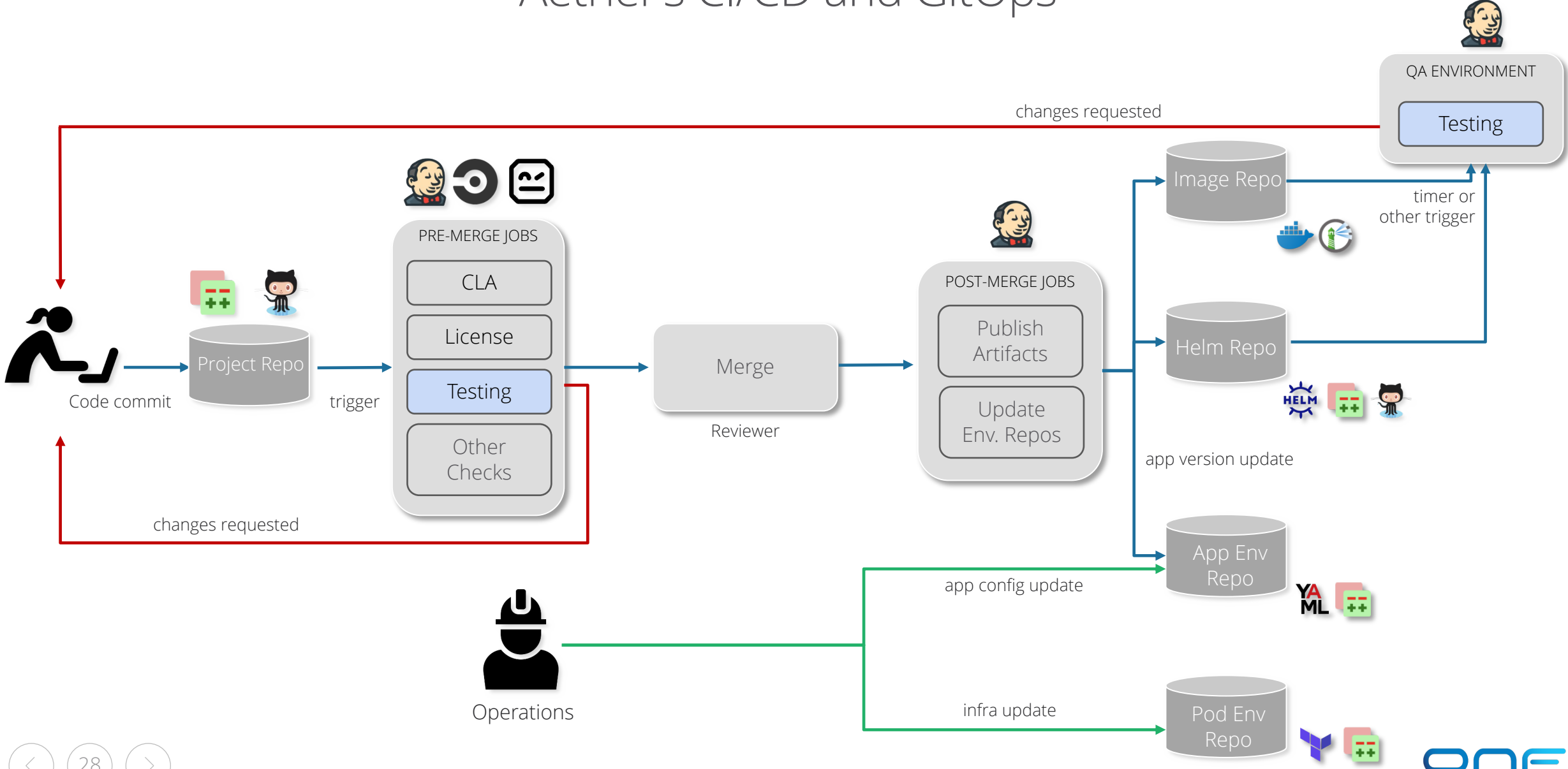

Aether's CI/CD and GitOps

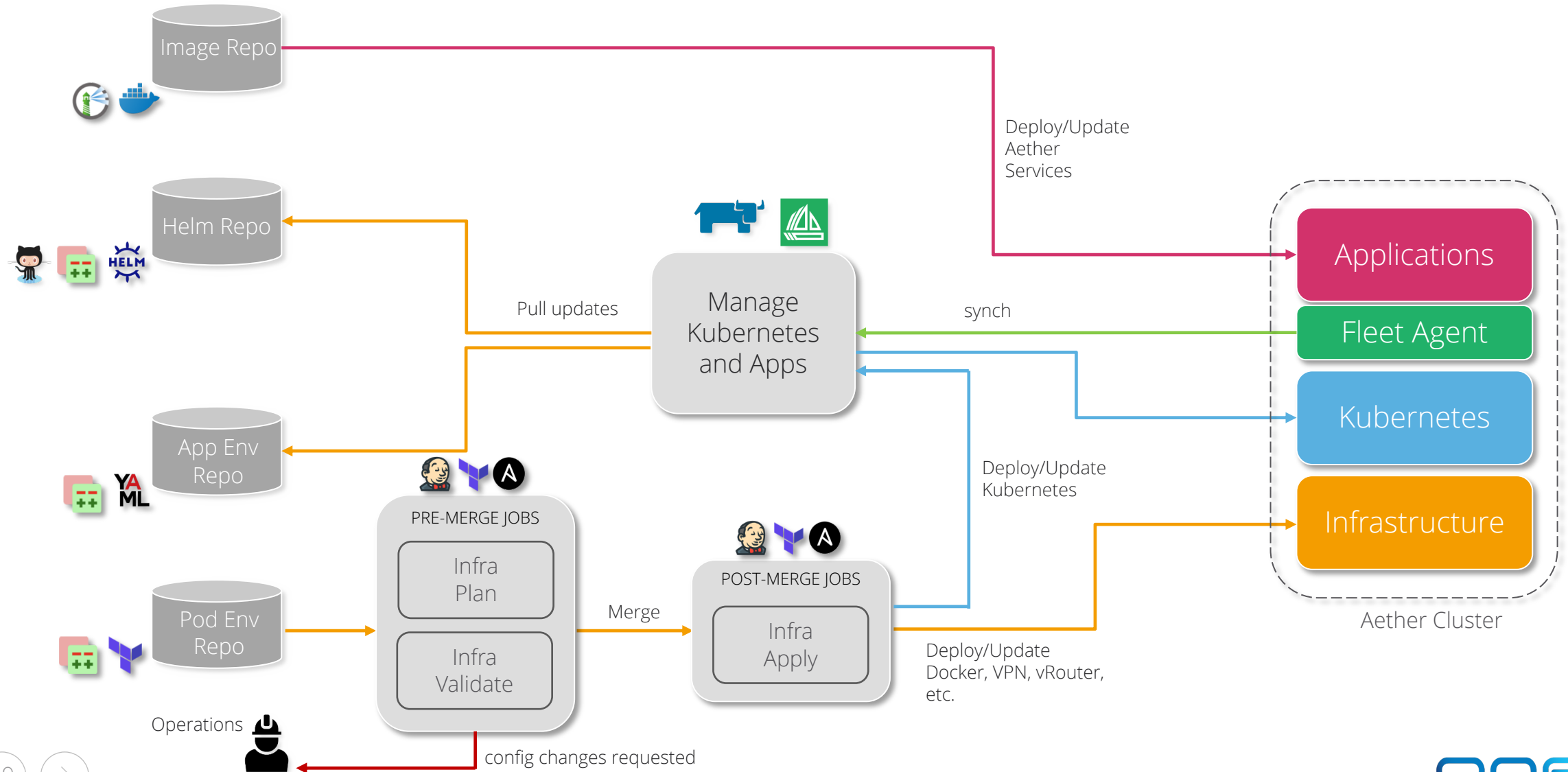

Aether Offers APIs at multiple hierarchies

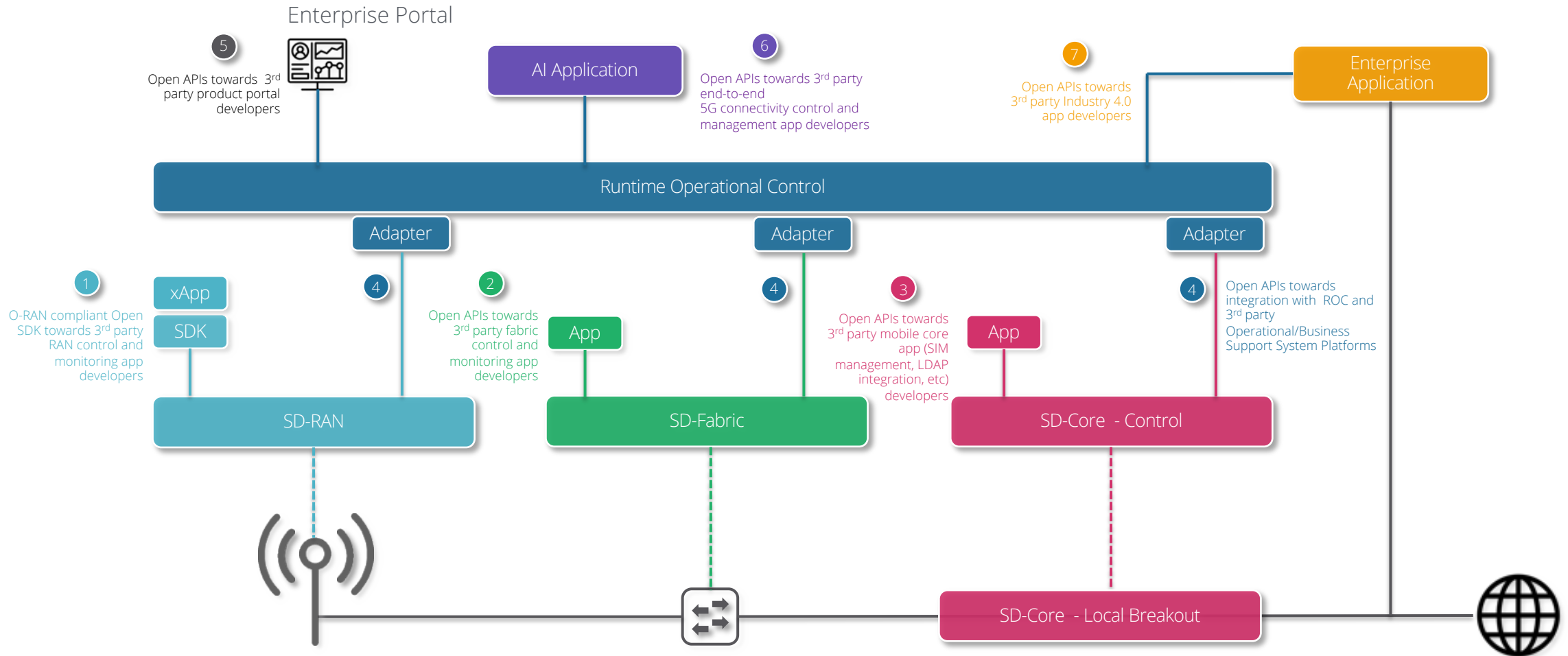

Aether has been operational for over 2 years



An outdoor trial with DT is now live



Providing connectivity in the DT Building Courtyard using Aether's fully disaggregated, software-defined, deeply programmable, cloud-enabled and operated private 5G and 4G networks



3 5G and 1 4G Radio Units are mounted on the poles in the courtyard with fiber connections to Aether Edge Cloud inside the building



 [Trial Video](#)

Broadband connectivity over 5G and 4G is now live. The networks will remain operational for the foreseeable future with new features being continuously added.



The Berlin Aether Edge is deployed inside the Deutsche Telekom data center in the building and is composed of COTS and P4-switches. This edge cloud is connected to the central cloud running from Google Cloud

Takeaways

Aether is an amazing open-source platform for private 5G and connected edge cloud that is innovative, highly programmable, multi-cloud supporting, feature rich, and for all practical purposes, near production grade.

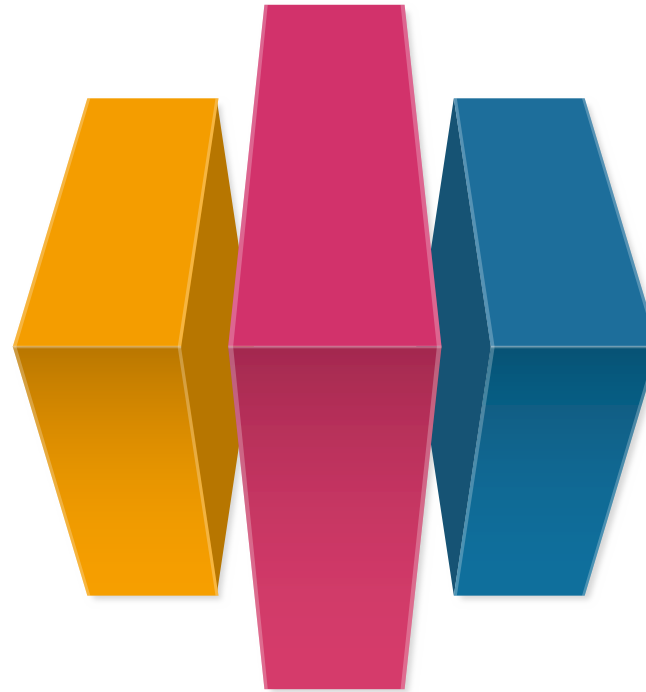

We are open-sourcing it at the perfect time – private 5G is potentially a huge emerging market and its adoption is starting to pick up.

With Aether's rich set of APIs, the ecosystem can easily take it, add their own innovations on it, and run with it.

Business Opportunities

Aseem Parikh
VP Solutions & Partnerships

Commercial Adoption directly Correlates to Maturity & Consume-ability of ONF Open-Source Artifacts

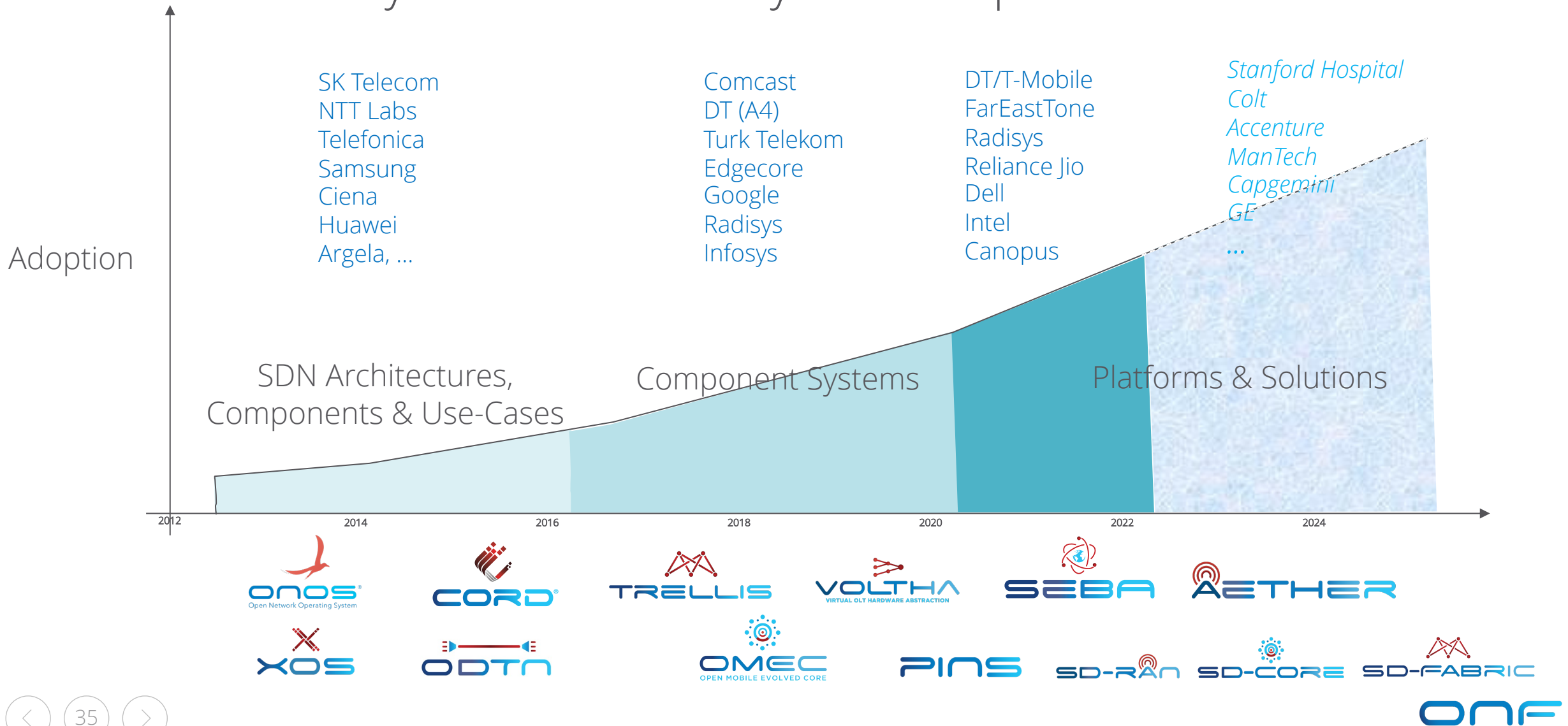

Aether 5G+Edge Platform

Key to Unlock \$50+B Enterprise Infrastructure Market



The 5G edge computing value opportunity
 A key pillar in the global economic recovery

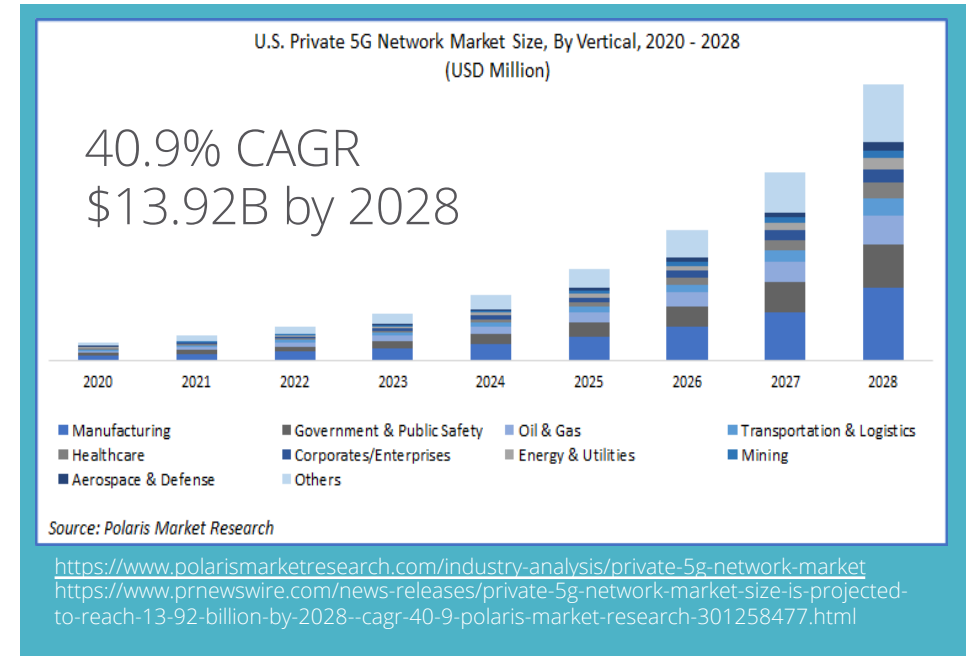
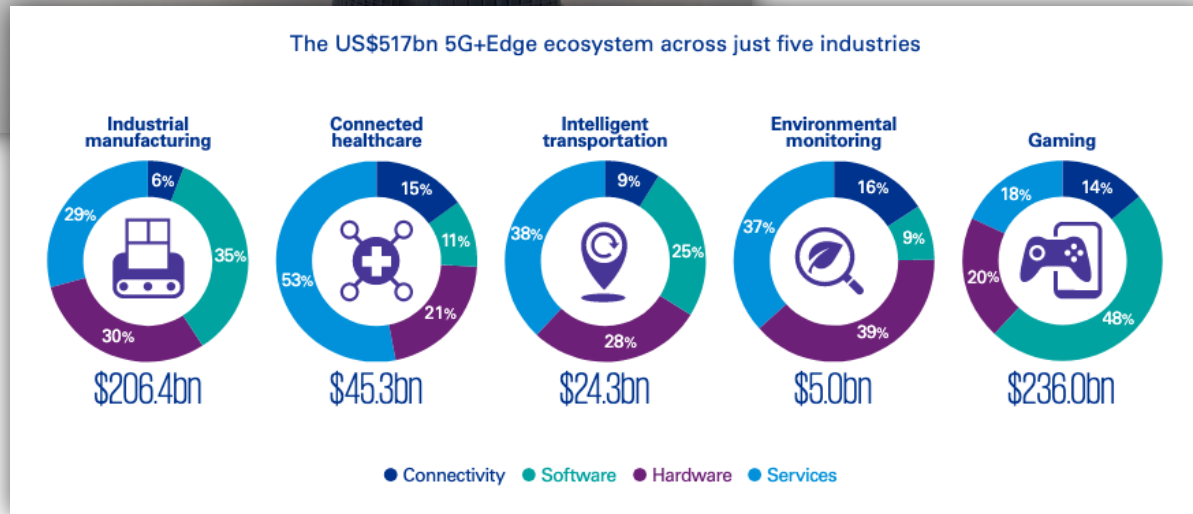

<https://home.kpmg/xx/en/home/insights/2020/06/the-5g-edge-computing-value-opportunity.html>

ONF Component Systems Have Broad Industry Appeal

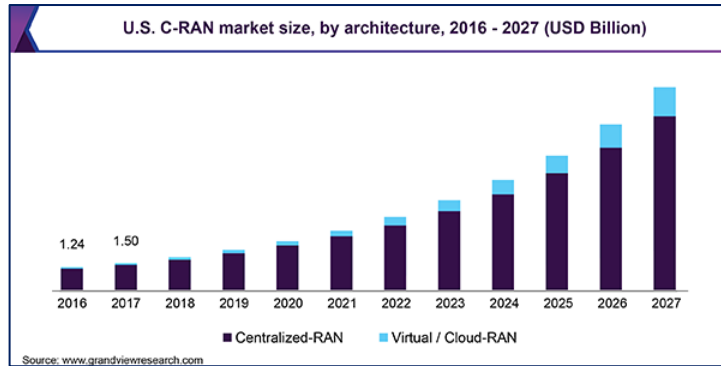

RAN Market is poised for disaggregation

Operators like AT&T, DT, Rakuten, China Mobile are pushing Open RAN based solutions for innovation and competition

Tech Partners like Intel and Facebook are developing AI/ML driven RAN xApps to advance spectrum efficiency and open RAN ecosystem

Size: Dell'Oro Predictions for 2024:

- RAN revenue to reach \$200B
- 5G NR RAN investments to surpass \$100 Billion
- 5G NR small cells will be 10-20% of overall 5G NR market

<https://www.delloro.com/news/worldwide-ran-revenues-expected-to-reach-0-2-trillion-through-2024/>

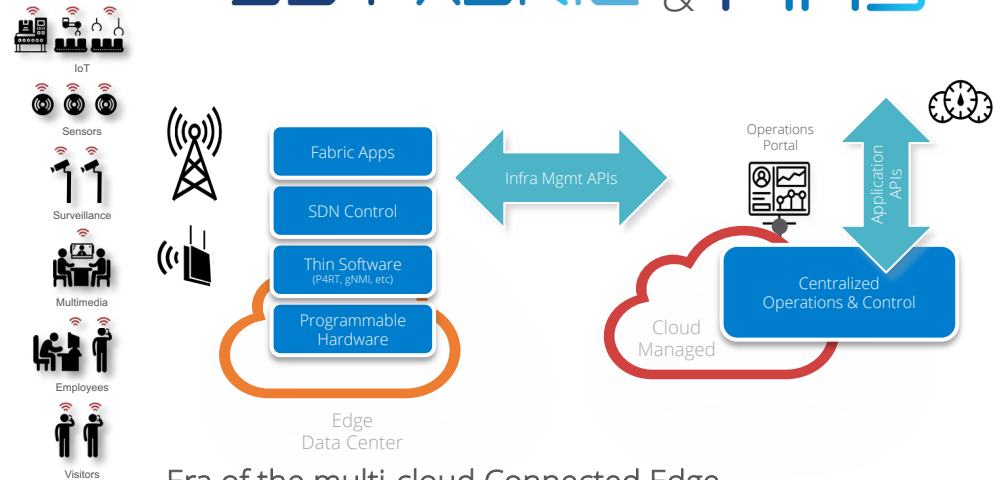

Era of the multi-cloud Connected Edge

Needs of the new datacenter fabric

- Lines between servers and networking are blurring
- Deeply Programmable, Developer Optimized with APIs
- Cloud Orchestrated and Managed
- Resilient and Self-Healing

Markets and Markets predicts the Global Data Center Fabric TAM to be \$4.2B by 2026

<https://www.marketsandmarkets.com/Market-Reports/data-fabric-market-237314899.html>

How did ONF achieve this great result?

Bill Snow
Chief Development Officer

Original Mission (2011)

*Accelerate innovation and bring CAPEX and OPEX efficiencies to Network Operators
Leverage SDN, Disaggregation and Open Source*

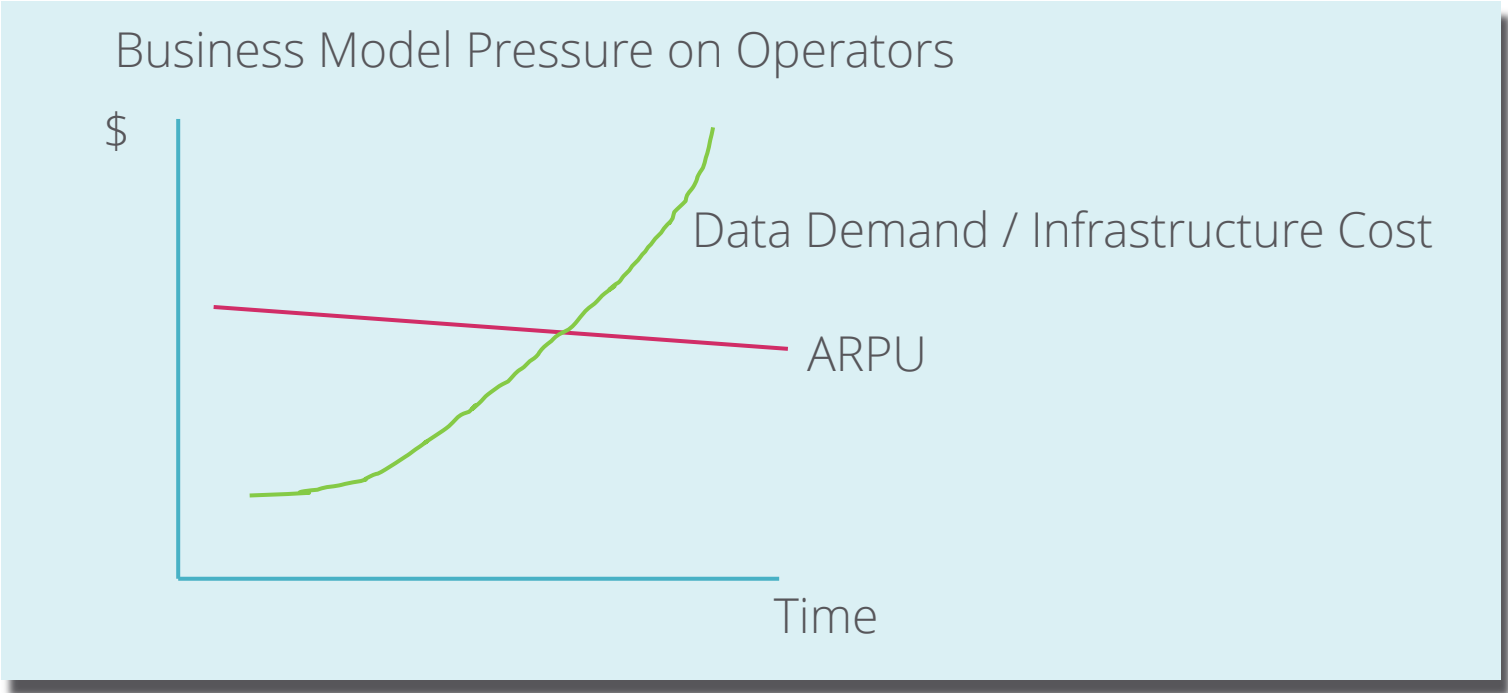

ONF became a trusted partner to operators
Non-profit
Mission oriented

ONF Needed a New Open Source Model

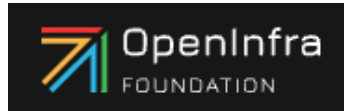

...



No development team

- Manage projects, community
- Adopt new technology
- Build consensus
- Incremental
- Serve community

Developer team key to organization

- Drive agenda for innovation
- Break technical “barriers”
- Transformational
- Working systems
- Serve end customer

Could ONF Staff Such An Organization?

Concerns

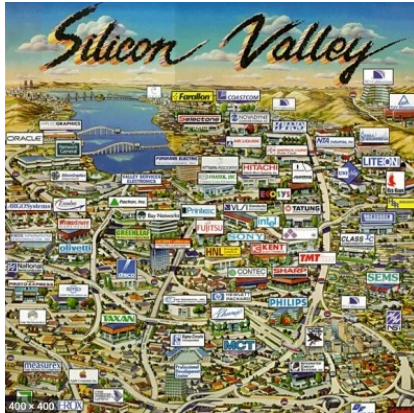

Hiring is tough
Little SDN talent
Non-Profit
Learn SDN, then move on

Realities



Top leaders in SDN – Nick, Guru, Larry
Early A-team of developers
Strong partnerships – Intel, Google...
Compelling mission

How We Hired "Smart, Gets Things Done*"



SDN, mission passion
PhDs wanting to build systems
Relations, intern program
Distributed Systems



SDN, mission passion
Best development practices
Quality in operations – CI/CD
Distributed Systems

Build a Great Culture

- Compelling mission, bigger than one's self
- Flexible, flat organization
 - Low friction to get work done, ability to “flow” between projects
- Commitment - aggressive goals and meaningful challenges
- Latest technologies and methods
- Transparency
- Mutual respect

Come and build on it

Timon Sloane
VP Marketing & Ecosystem

Entering a New Phase in ONF's Journey

Now that we've seeded the industry through partner funded development,
we've released everything to open source
to enable broad adoption to expand the impact of our work

Phase 1

- Evangelizing for SDN
- Standardizing OpenFlow

2011 - 2015

Phase 2

- Partners (operators) jointly fund development of platforms
- Operators begin to deploy platforms into production

2016 - 2021

New - Phase 3

- Expand consumption & adoption
- Broaden our developer community
- Activate the open source multiplier effect for our projects

2022 -

What you can do next

- Come consume and use the platforms
 - Deploy private 5G
 - Deploy P4 programmable fabrics
- Where you can extend the work
 - Support new silicon targets: port SD-Fabric and PINS on switches, extend work to IPU/DPU and hosts
 - Bring new RAN components (RU/DU/CU) into SD-RAN
 - Build xApps on top of SD-RAN
 - Build Industry 4.0 applications on top of Aether
 - Next-G Research: leverage Aether as a whole, or components: SD-RAN, SD-Core and SD-Fabric
 - Single best platform for bringing up your own 5G network
 - Most programmable platform, easy to customize and extend

Our journey is only possible because of ONF's community

Thank You !



Thank you