



Aether v2.1 Techinar

February 16 | 9am PDT



Scott Baker, Badhrinath Padmanabhan - Intel
Larry Peterson - ONF

Agenda

- Aether v2.1 Overview
- Configuration Model Enhancements
- Scalability and Stability Features
- Complex Validation Rule Support
- SD-Core Integration
- How to Get Involved with Aether
- Q&A

Aether Architecture

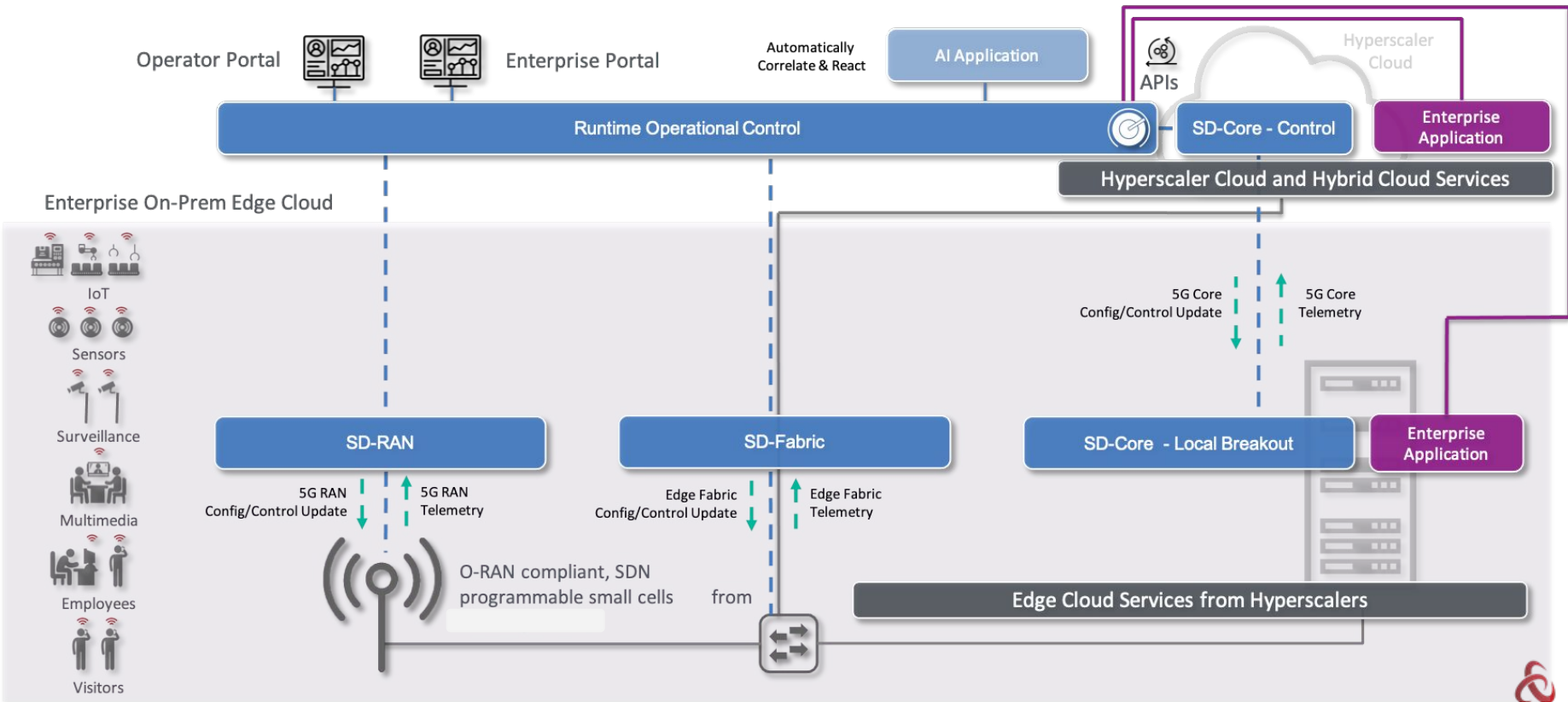

Aether: Single Cloud, Multiple Enterprise Sites

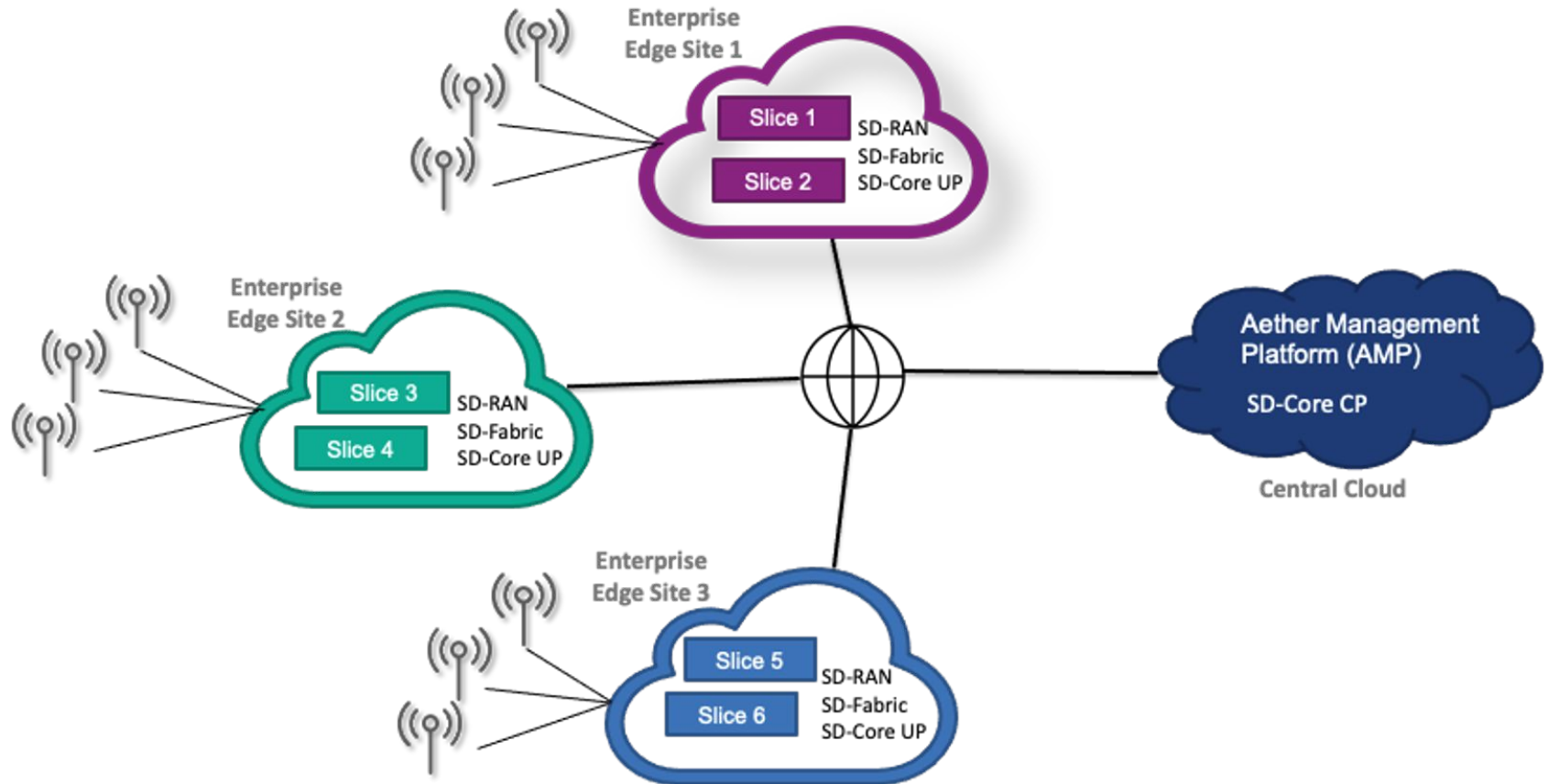

Aether Service Abstraction

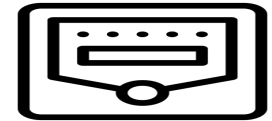
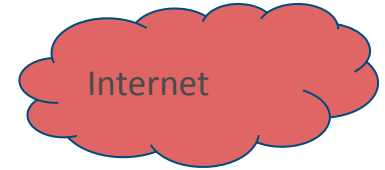
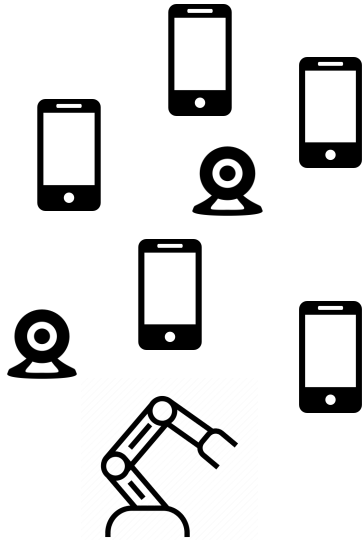

Goal of Aether is to connect devices to applications.

Control

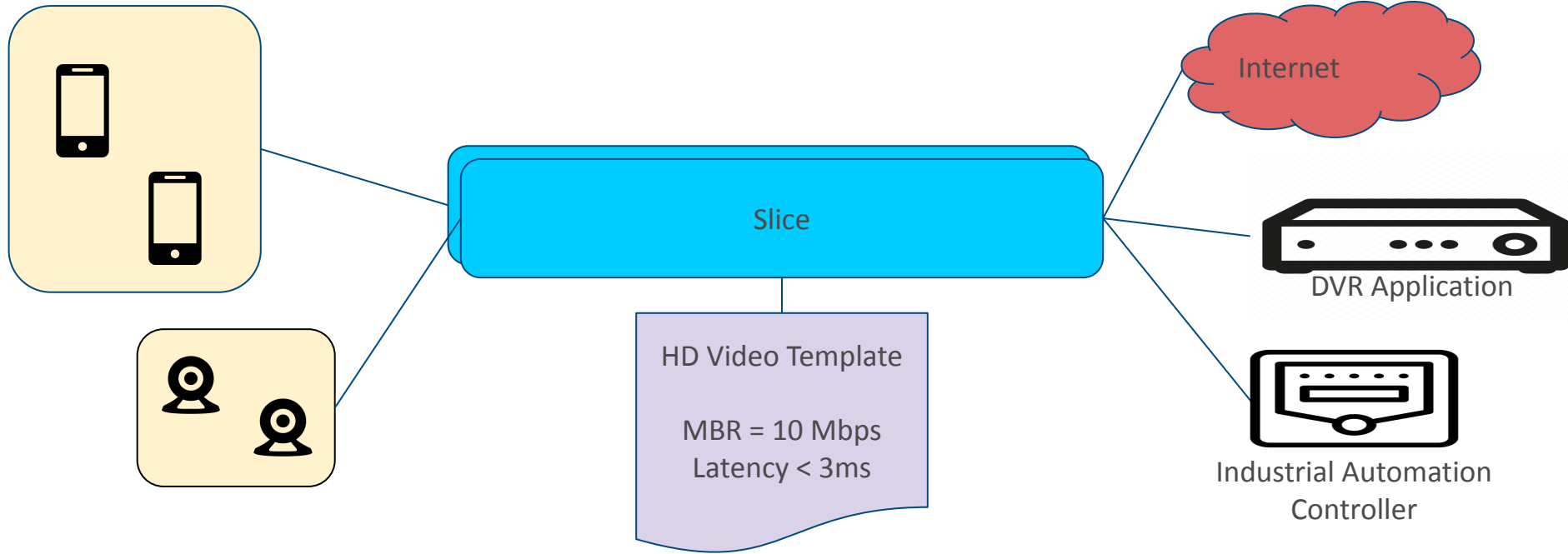

Administrator can group the devices for convenience.
Administrator can associate devices with applications via a Slice.
ONF gives the user templates to abstract out 4G/5G details.

Analytics



Analytics are as important, if not more important than control.

Aether includes a robust analytics solution based on Grafana, Prometheus, and Elastic.

Service Abstraction is a set of models

The Aether Service Abstraction is a set of models, some of which are managed by Aether Operations, and some are managed by the enterprise administrator.

We will see these models in use in the GUI shortly.

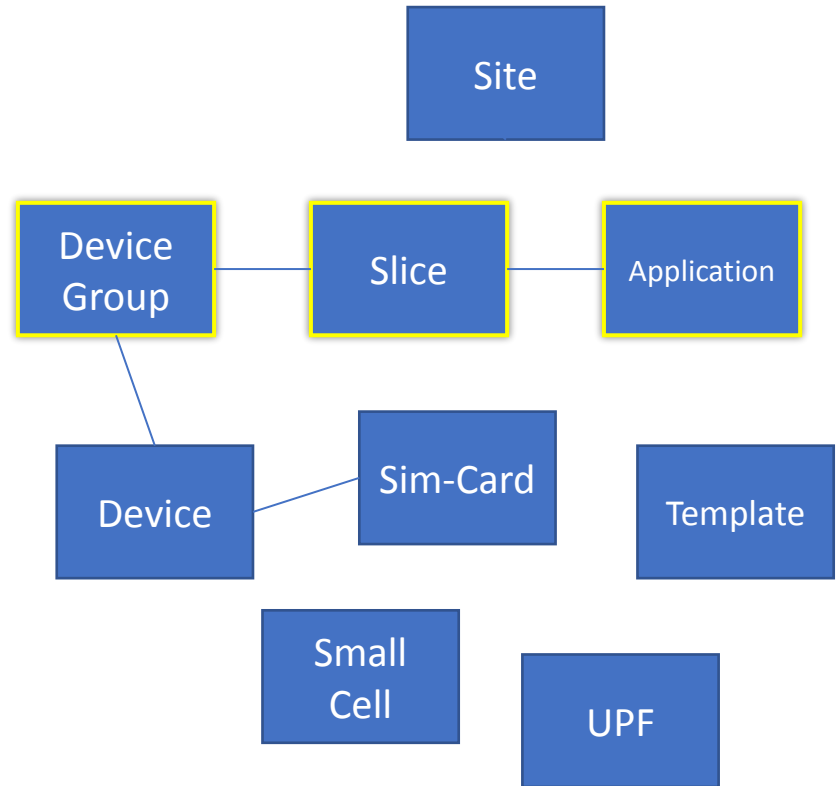

The models are available via a Portal

- Portal supports both control and analytics, side-by-side.
- RBAC to isolate Enterprise users from one another.

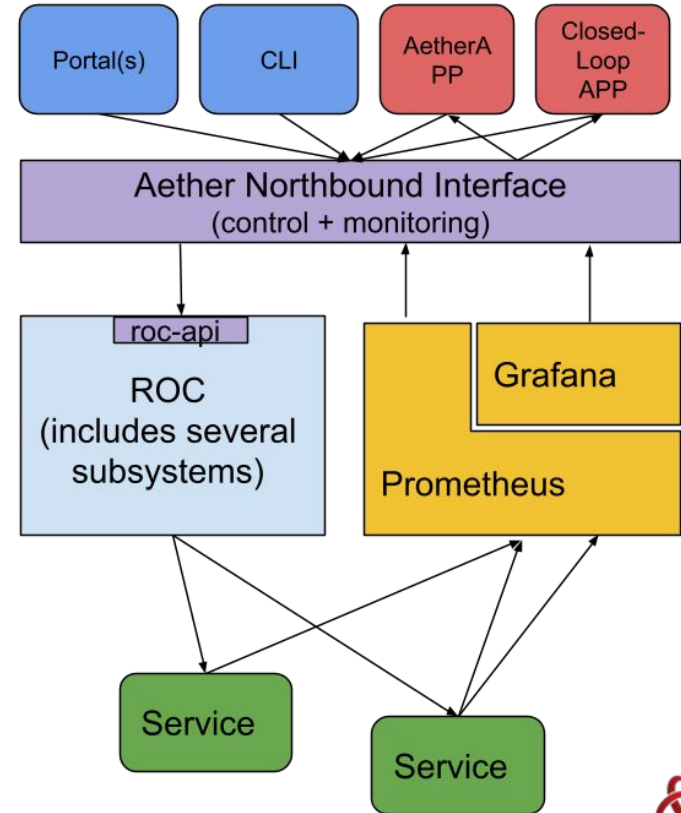

API

- The portal sits atop a pair of APIs.
- Those same APIs can be used for other applications.
- This is how we “5g Enable” / add Aether value.
- The control API is protected by RBAC and authentication.
- The monitoring API is not yet protected.

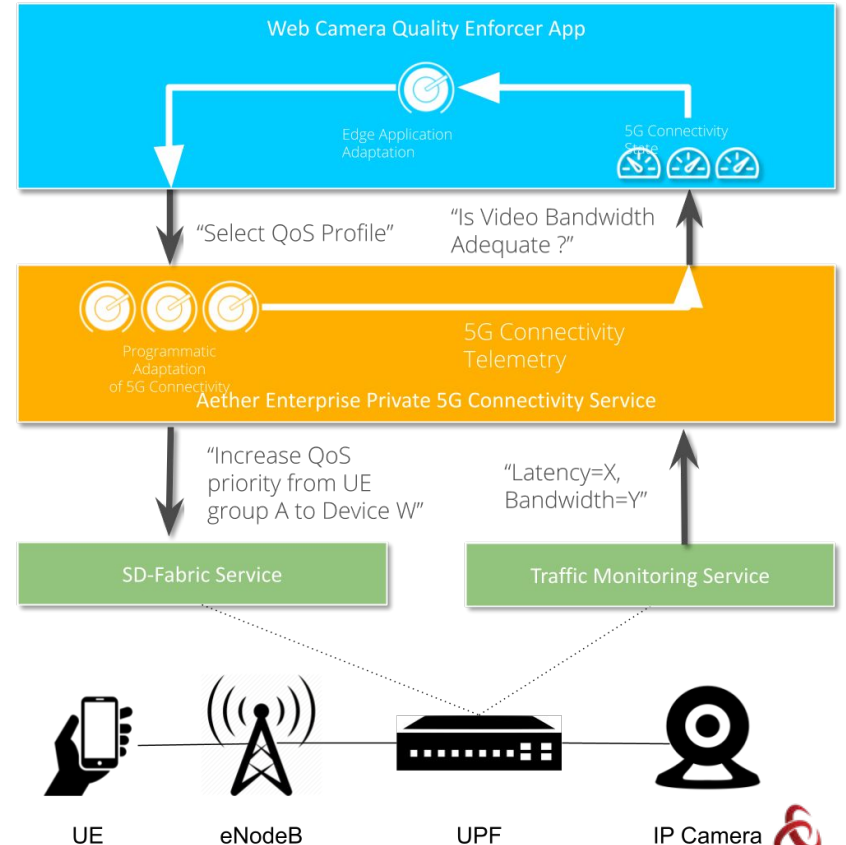

Configuration Model Improvements

- One Target per Enterprise
- Improves scalability and simplifies API
- One adapter pod may still service multiple targets/Enterprises, or multiple adapter pods may be used
- Several fields changed to support leading zeroes

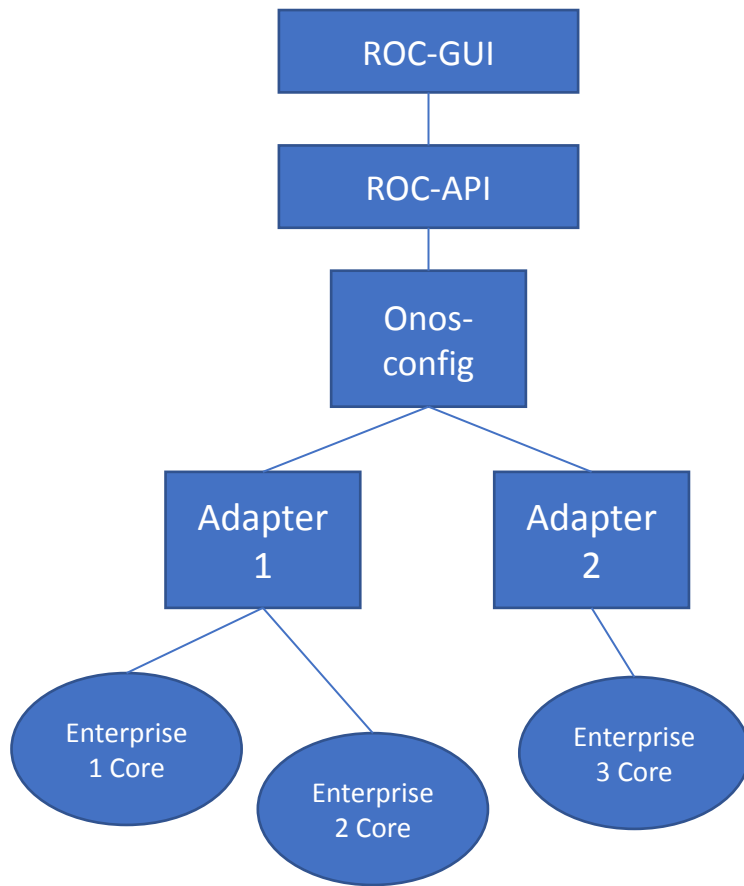

Configuration System Improvements

- onos-config controllers were redesigned and reimplemented in TLA+
 - Machine-checked formal specification language
- New gNMI extensions support Set and Get configurability
- Southbound support for non-persistent targets
 - A failed non-persistent target can get a configuration push on restart
- Limits on request size
 - Prevents huge atomic requests from causing stability issues

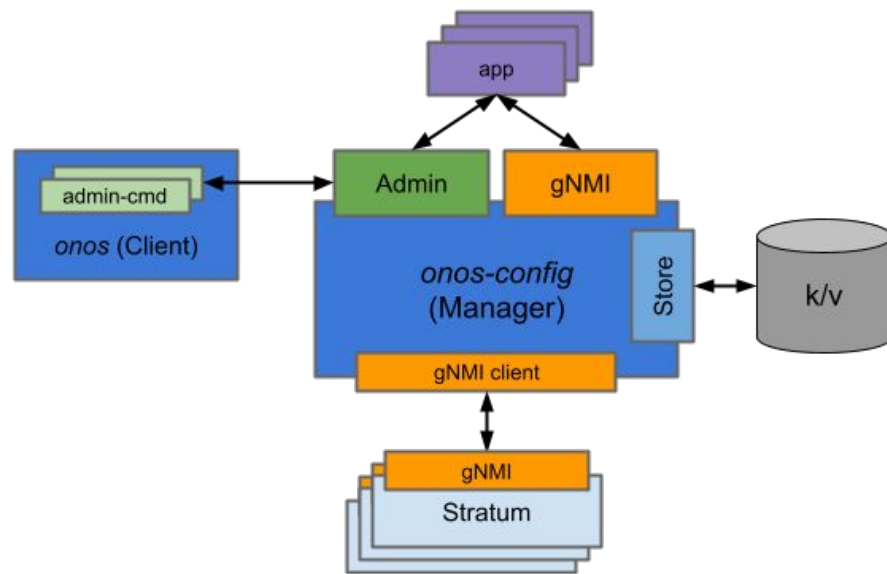

Complex Validation Rules (Guardrails)

- Yang “Must” rules allow enforcement of critical invariants in the data models.
- The must rules use industry-standard well-known xpath syntax
- Must rules are enforced in the API

```
# Example: Validate device group to site membership

must
"count(site:slice[set-contains(following-sibling::site:slice/site:device-group/@site:device-group,
site:device-group/@site:device-group)]/@site:slice-id) = 0" {

    error-message "a device group cannot be used in more than one slice in a site";

    description "device-group must only be used by one slice at a time";

}
```

SD-Core 1.2 Overview

- SD-Core 1.2 Released on Oct 11, 2022
- **Highlight** - Move towards cloud native 5G network functions
- <https://opennetworking.org/events/sd-core-v1-2-0-techinar/>
- SD-Core 1.2 [Release blog](#)
- SD-Core 1.2 [Release Notes](#)
- Helm Charts can be found on [Charts Repository](#) . Helm Charts code is tagged & branch created
- SD-Core Document [Website](#) has SDCore-1.2 branch
- Thank You all Community Members !
 - Intel, Infosys, CPQD, Purdue University, GS Lab
 - There are more individuals contributing with individual Contributor License Agreement (CLA)

NRF Keep Alive Support

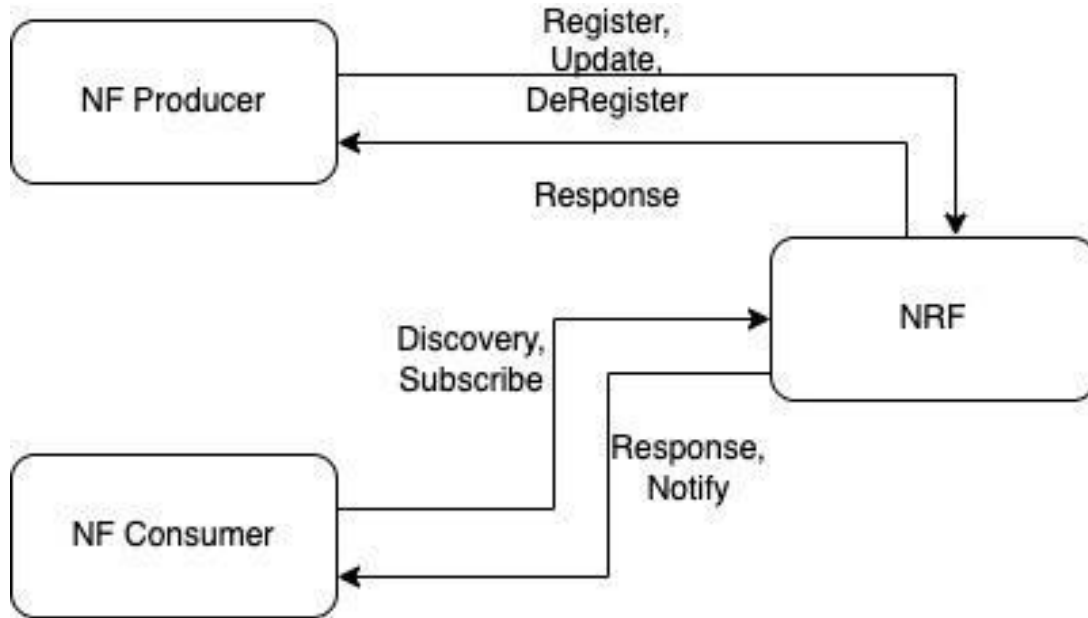

- Feature is default disabled. Enabled by changing override values for NRF
- Keep Alive Support in NRF
 - Configuring Heartbeat Timer Value
 - Handling Heartbeat Messages from the NFs
 - Deletion of NFProfile from DB on Heartbeat timer expire
 - Discover returns multiple profiles
- Keep Alive Support in other NFs
 - Sending NFProfile update message to NRF on Heartbeat Timer expire
 - Send Deregistration message to NRF (graceful exit)
- Future Release*
 - *NRF cache and NRF notification support shall come in upcoming release*

AMF Changes

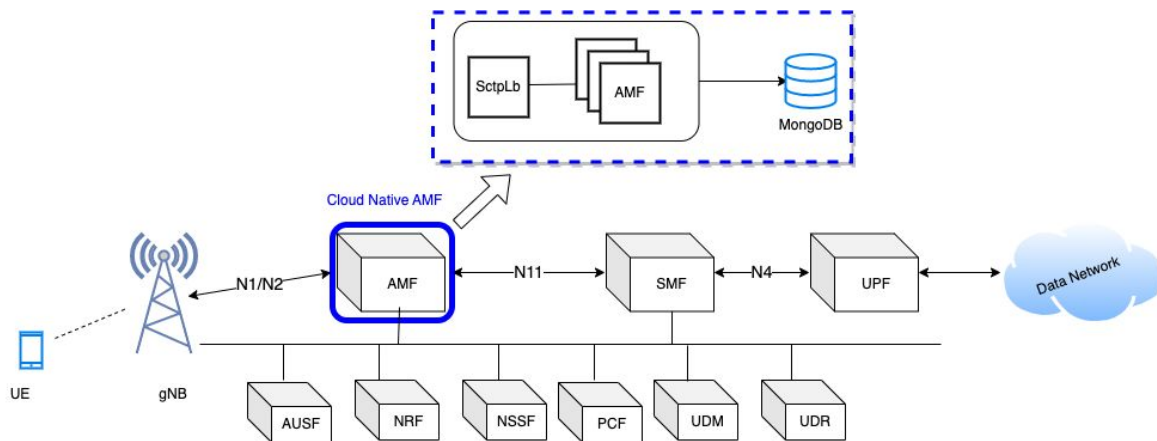

- New K8s Pod SctpLb
- Accept and manage gNodeB connections
- GRPC communication between SctpLb and Amf Service
- Handles Amf Instance Down/Up Notifications
- Distributed Resource Sharing Module (DRSM) used to share resource IDs among AMFs
- SctpLb is disabled by Default and can be enabled through helm chart override values

SCTP Load Balancer

- Tracks AMF instances in the deployment
- SCTPLb just reads SCTP socket message. No ngap message decoded.
- Round-Robin Distribution of Sctp Messages over grpc channel to AMF
- Redirect Support for forwarding Sctp Messages to a particular Amf Instance
- If instance is detected to be down, then remove the AMF from Pool
- Future release
 - *Decode NGAP message and forward message to correct AMF instance*
 - *Multiple SctpLb support*
 - *Will help in scaling number of gNBs connected to core.*
 - *NRF api integration in SctpLb to discover as custom NF*

AMF DB support

- DB Read when context is not found in memory
- DB create/update on success of following procedures
 - ✓ Registration Procedure
 - ✓ Deregistration Procedure
 - ✓ Service Request Procedure
 - ✓ PDU Session Setup Procedure
 - ✓ PDU Session Release Procedure
 - ✓ AN Release Procedure
 - ✓ GUTI Registration Procedure
 - ✓ Network Initiated Deregistration Procedure
 - ✓ Context Replacement: Registration on Registration
- DB Delete on Completion of following procedures
 - ✓ Deregistration Procedure
 - ✓ Network Initiated Deregistration Procedure
- REST API support to fetch Active UEs Context from DB
- REST API to purge Subscriber from AMF

SMF Changes

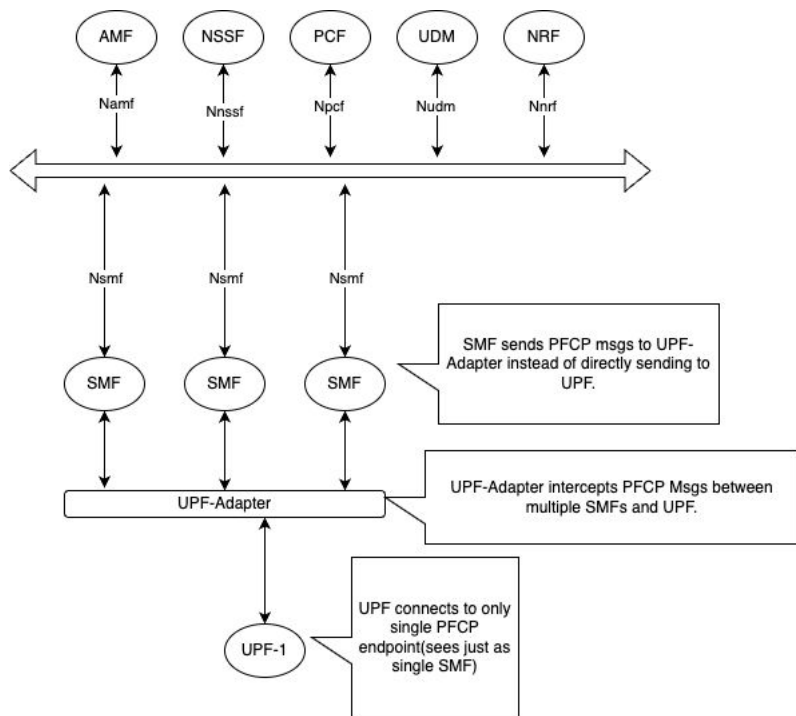

- Introduced UPF adapter as PFCP endpoint from SMF side
- UPF adapter talks to one or more UPF
- UPF-Adapter acts like Mux-Demux for PFCP messages between multiple SMF instances and UPF.
- The UPF-Adapter intercepts and modifies certain fields before sending PFCP msg to actual UPF.
- Similar handling is done for the response from UPF towards SMF.
- PDU Session preservation in Database
- Two or more SMF instance supported. Scale up/down of SMF instance supported

SMF Changes

- PDU Session preservation in Database
 - SMF shall preserve PDU Session in Database after every procedure to maintain latest updates. This shall ensure stateless support to operate on PDU session at any SMF instance.
- UPF support for handling multiple SMF instances association
 - UPF-Adapter introduced to handle multiple SMF PFCP associations with same Node-Id towards UPF.
- NRF Keep-Alive support. Send periodic NRF profile update
- Unique ID/IP-Address Management across all the Instances
 - Distributed Resource Assignment handling using DRSM
 - UPF supported UE address allocation
 - With support of DRSM module, during the recovery of any SMF instance, other NFs shall claim resources of that instance and shall become new owner of the resources(e.g., SEID/TEID Pools)
- AMF shall forward ongoing procedure to alternate SMF if procedures times out/fails with current SMF instance
 - Retransmission of message to alternate SMF
 - NRF notification will reduce the signalling delays during pod restart

gNBSim Changes

- Support for Custom Profile
 - Iterate over procedures as per configured steps
 - Delay between procedures possible
 - StepTrigger to execute procedures one by one. Step profile can be enabled. Step trigger can be given through API. [Example here.](#)

```
customProfiles:
  customProfiles1:
    profileType: custom # profile type
    profileName: custom1 # uniquely identifies a profile within application
    enable: false # Set true to execute the profile, false otherwise.
    execInParallel: false #run all subscribers in parallel
    stepTrigger: true #wait for trigger to move to next step
    gnbName: gnb1 # gNB to be used for this profile
    startImsi: 208930100007487
    ueCount: 5
    defaultAs: "192.168.250.1" #default icmp pkt destination
    opc: "981d464c7c52eb6e5036234984ad0bcf"
    key: "5122250214c33e723a5dd523fc145fc0"
    sequenceNumber: "16f3b3f70fc2"
    plmnId: # Public Land Mobile Network ID, <PLMN ID> = <MCC><MNC>
      mcc: 208 # Mobile Country Code (3 digits string, digit: 0~9)
      mnc: 93 # Mobile Network Code (2 or 3 digits string, digit: 0~9)
    startIteration: iteration1
    iterations:
      #at max 7 actions
      - "name": "iteration1"
        "1": "REGISTRATION-PROCEDURE 5"
        "2": "PDU-SESSION-ESTABLISHMENT-PROCEDURE 5"
        "3": "USER-DATA-PACKET-GENERATION-PROCEDURE 10"
        "next": "iteration2"
      - "name": "iteration2"
        "1": "AN-RELEASE-PROCEDURE 100"
        "2": "UE-TRIGGERED-SERVICE-REQUEST-PROCEDURE 10"
        "repeat": 5
        "next": "iteration3"
      - "name": "iteration3"
        "1": "UE-INITIATED-DEREGISTRATION-PROCEDURE 10"
        #"repeat": 0 #default value 0 . i.e execute once
        #"next": "quit" #default value quit. i.e. no further iteration to run
```

gNBSim Changes

- Regular/default profiles
 - Procedure list is fixed per profile
 - Execute Subscribers In Parallel to simulate 100+ calls
 - Step profile can be enabled. Step trigger can be given through API. [Example here.](#)
 - Custom Profile and Regular profile
 - Delay between procedures **can not** be provided
- Add new calls in [existing profile](#)
 - Works when step profile is enabled
- REST Api to trigger new [profile execution](#)
- Dnn, slice Information can be configured
- Future release
 - gNB handovers, gNB deployment as container, error indication, gtpu echo handling, negative testing, external interface to send uplink traffic

```
profiles: # profile information
- profileType: register # profile type
  profileName: profile1 # uniquely identifies a profile within application
  enable: false # Set true to execute the profile, false otherwise.
  gnbName: gnb1 # gNB to be used for this profile
  startImsi: 208930100007487
  ueCount: 5
  defaultAs: "192.168.250.1" #default icmp pkt destination
  opc: "981d464c7c52eb6e5036234984ad0bcf"
  key: "5122250214c33e723a5dd523fc145fc0"
  sequenceNumber: "16f3b3f70fc2"
  dnn: "internet"
  sNssai:
    sst: 1 # Slice/Service Type (uinteger, range: 0~255)
    sd: 010203 # Slice Differentiator (3 bytes hex string, range: 000000~FFFFFF)
  execInParallel: false #run all subscribers within profile in parallel
  plmnId: # Public Land Mobile Network ID, <PLMN ID> = <MCC><MNC>
  mcc: 208 # Mobile Country Code (3 digits string, digit: 0~9)
  mnc: 93 # Mobile Network Code (2 or 3 digits string, digit: 0~9)
```

Documentation Enhancements

- Updated Configuration Guide
- [UPF deployment](#)
- [QoS configuration](#)
- [Release Notes for 1.2](#)
- [Application Filtering Rules](#)
- Default Aether in a Box (AiaB) override file has newly added comments to explain configuration
- [Design Section](#) added to capture new design aspects
- Next Release features on [doc website](#)

Future Enhancements

- Details of next release targeted features available at [doc website](#)
- Documentation for UPF deployment
 - Standalone Control + edge
 - Distributed Edge
- Supporting metrics from multiple NFs and creating dashboard
 - Making dashboard available for AIAB for 5G
- gNBSim feature extensions
- Spin up/down NF instances based on metrics such as CPU utilization, memory utilization, or custom metrics
- NRF cache and NRF notification support
- Multiple SctpLb Instance Support
 - NGAP Decode to forward messages to a particular Amf Instance
- Multiple UPF adapter support
 - UPF initiated message handling
- To be addressed in a future SD-Core release

How to Get Involved with Aether

Join the Community

- Register for an ONF Account → <https://opennetworking.org/register/>
- Join ONF Slack Workspace → <https://onf-community.slack.com/>

Read Up on Aether

- Private 5G → <https://5g.systemsapproach.org/>
- Edge Cloud Operations → <https://ops.systemsapproach.org/>

Download and Run Aether

- Aether OnRamp → <https://github.com/SystemsApproach/aether-onramp>
→ <https://5g.systemsapproach.org/software.html>

Aether OnRamp

From Getting Started to Operational Deployment

- Learn About and Play with Aether
- Develop for and Contribute to Aether
- Deploy and Operate Aether

Staged Progression

- Install a Single Node Edge Site (~AiaB)
- Incorporate GitOps Tools
- Add Physical gNBs
- Optimize the Network (SR-IOV)
- Scale Up Servers and Slices
- Integrate with SD-RAN



Thank You